

2UCD120000E002_K

PCS100 UPS-I

Industrial Uninterruptable Power Supply

Technical Catalogue





ABOUT THIS DOCUMENT

ABB Power Conditioning

Leading the industry in innovation and technology, ABB provides power conditioning for many of the world's foremost organizations, ensuring the continuous operation of small, medium to large businesses are protected on a global scale.

ABB's Power Conditioning portfolio is a unique line up of low and medium voltage power conversion technology that is part of the product group, Power Protection.

The portfolio consists of static frequency converters, UPSs, voltage and power conditioners that demonstrate highly reliable and cost-effective performance. With this product portfolio, ABB offer efficient power conditioning solutions that are specifically designed to solve power quality problems and stabilize networks.

Covering applications from data centers through to complete industrial plant protection, micro grid systems and shore-to-ship supply, ABB have the power conversion technology for every need. Starting from a few kVA to many MVA and a wide range of supply voltages.

It's business as usual with power conditioning technologies in place.

Power Conditioning Product Portfolio

Product Line	Typical Problems	Product
Industrial UPS	Utility deep sag and surge correction	PCS100 UPS-I Industrial UPS
	Utility outage protection	HiPerGuard MV UPS
Voltage conditioning	Utility sag and surge correction	PCS100 AVC-40 Active Voltage Conditioner for sag correction
	Load voltage regulation	PCS100 AVC-20 Active Voltage Conditioner for voltage regulation
Frequency Conversion	50/60 Hz conversion	PCS100 SFC Static Frequency Converter
	Frequency fluctuation	SureWave



Document Information

Copyright notice

The information in this manual is subject to change without notice. This manual and parts thereof must not be reproduced or copied, or disclosed to third parties, nor used for any unauthorized purpose without written permission from ABB Ltd. The hardware and software described in this manual are provided under a license and may be used, copied, or disclosed only in accordance with the terms of such license.

Document identification

Ownership: ABB Ltd., Power Conditioning Products

Document number: 2UCD120000E002

Issue date: 11/10/2023

Revision: Rev K

Contact information

Address: ABB Ltd. 111 Main North Road, Napier, New Zealand.

Website: <https://new.abb.com/ups>

Contents

About This Document	2
ABB Power Conditioning.....	2
Power Conditioning Product Portfolio.....	2
Document Information.....	3
Voltage Sags – The Problem	7
PCS100 UPS-I Industrial uninterruptible power supply	8
How it works.....	8
PCS100 UPS-I Benefits	9
Reduce the cost of power quality events.....	9
Improved plant operation.....	9
Versatility of installation.....	9
Industries and Applications	10
PCS100 UPS-I VALUES	11
Very high efficiency.....	11
Small footprint.....	11
Specifically designed for industrial loads.....	11
Very high fault current capacity.....	11
Modular design.....	11
Generator walk-in algorithm.....	11
Wide power and voltage range.....	11
Connectivity.....	11
Modular construction.....	11
Sophisticated control software.....	11
Graphical touch screen interface.....	11
Functional Description	12
PCS100 UPS-I Operation Details.....	12
TRANSFER FUNCTION.....	14
Generator walk-in.....	15
Subassemblies	16
Utility Disconnect.....	16
Inverter Modules.....	16
Advanced redundancy.....	17
Inverter Enclosure.....	17
Float Charger.....	17
Coupling Transformer.....	17
Fail-Safe Bypass.....	17
Integrated Fail-Safe Bypass.....	17
Optional Fail-Safe Bypass.....	17
External Fail-Safe Bypass.....	17
Energy storage	18
Ultracapacitor Energy Storage.....	18
Ultracapacitor Monitor Board.....	18
Ultracapacitor Energy Storage features:.....	18
Battery Energy Storage.....	19
Battery Energy Storage features:.....	19
Models without Batteries.....	19
Technical Specification	20
How to Select a PCS100 UPS-I	23
Type Code.....	23
Type Code Parameters:.....	23
PCS100 UPS-I Sizing Tool.....	23
Calculation of Autonomy Period at Specific Load levels.....	23
PCS100 UPS-I model Selection.....	24

Application Active Load Calculation 24
 Energy Storage Rating Determination 24
 Relative Loading Calculations 24
 Autonomy Determination 24
 Storage Loading vs Autonomy Period 25
 Calculation of Autonomy Period at Specific Load Levels 25

advanced functionality 26
 Voltage Event Detection 26
 RMS Detector 26
 Transient Detector 26
 Frequency Detector 26

Ultracapacitor models 28
 220 V Ultracapacitor Models 28
 400 V Ultracapacitor Models 29
 480 V Ultracapacitor Models 31

battery models 33
 220 V Battery Models 33
 400 V Battery Models 34
 480 V Battery Models 36

Dimensions, Layouts and Clearances 38
 Dimensions and Weights 38

Individual enclosures 39
 Individual Enclosures – Plan View 39
 Individual Enclosures – Elevations 39
 Clearances 39
 Layout Plans – PCS100 UPS-I Subassemblies 40
 Back-by-Back Layouts 43

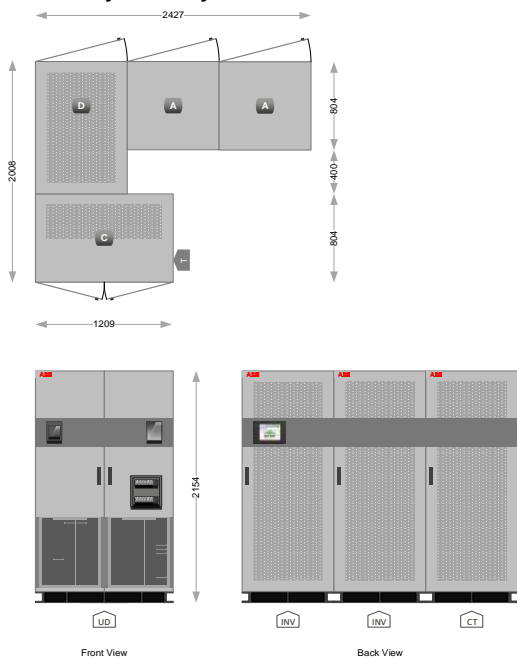

..... 43
 Layout Plans – Energy Storage 44
 Ultracapacitor Energy Storage 45
 Battery Energy Storage 45
 Layout Plans – Complete Systems Example 45
 Side-by-Side Layout 46
 Back-to-Back Layout 47

example systems 48

Options 49
 +BB Back-to-Back Layout Plan 49
 +FS2/FS4 Fail-Safe Bypass 49
 TE Cable Termination Enclosure 50
 +DMY Dummy Enclosure 50
 +NBxx Empty Battery Energy Storage Enclosure 50

- User Interface 51**
 - Graphic Display Module.....51
 - Remote Monitoring51
 - Remote Web Pages..... 52
 - Modbus TCP 52

- User Connections 53**
 - Power Connections 53
 - 900 A Utility Disconnect 53
 - 2200 A and 4200 A Utility Disconnect 53
 - Control Connections 54
 - Emergency Power Off (EPO) 54

- Installation Requirements 55**
 - Input Circuit Protection..... 55
 - Short Circuit Protection 55
 - Input Overload Protection – Utility Disconnect 55
 - Maintenance Bypass 55
 - Floor Requirements..... 55
 - Electromagnetic Compatibility (EMC) 55
 - Location 55
 - Phase Rotation 55
 - Power Systems 55
 - Harmonics 55
 - Load Imbalance 55
 - Supply transformer 55

- Service and Technical Support 56**
 - Comprehensive global services portfolio..... 56
 - Custom tailored service contracts..... 56
 - Life cycle management..... 56
 - Training..... 56
 - Engineering and technical support..... 56

- Additional Documents 57**

VOLTAGE SAGS – THE PROBLEM

Modern industries are becoming more automated and the sensitivity of processes to power quality events is increasing. Although utilities endeavor to supply reliable, high-quality power, voltage sags and surges will continue to be a fact of life, even with modern power networks. Even a short event of less than one cycle can cause processes to unexpectedly stop, potentially resulting in product damage, wastage and production shortages.

A voltage sag is not a complete interruption of power; it is a temporary drop below 90 percent of the nominal voltage level. Most voltage sags do not go below 50 percent of the nominal voltage, and they normally last from 2 to 10 cycles - or from 32 to 200 milliseconds. The depth of voltage sag depends on the physical distance between the fault location and customer's facility. Closer the distance deeper the sag will be.

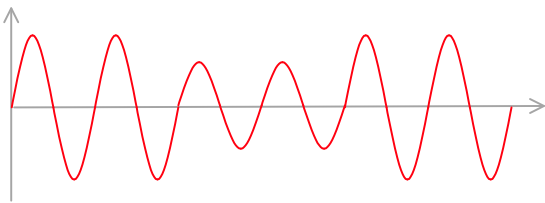

Some customers have two independent utility supplies and have means to switch the load to another supply, by means of automatic transfer switch or bus tie as shown below.

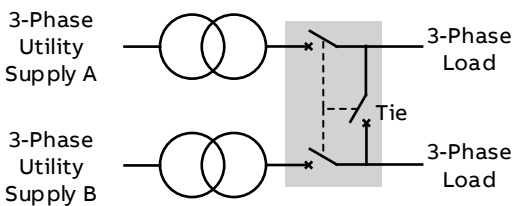

In this situation, the load will be transferred to the alternate supply if there is a network event such as voltage sag. During this transition to the other supply the load will experience an outage, and this can last up to few hundred milliseconds.

There are two sources of voltage sags: external, on the utility's transmission and distribution lines, and internal within the customer's facility.

Utilities continuously strive to provide the most reliable and consistent electric power possible. In the

course of normal utility operations, however, many things can cause voltage sags.

Weather is the most common cause of external sags and momentary interruptions all around the world. Thunderstorms and lightning strikes on power lines create line to ground faults causing voltage sags in a wide area.



High winds can blow tree branches into power lines, connecting the line with the ground and shorting between phases. A series of sags will occur as the branches repeatedly touch the power lines. Snow and ice buildup on power lines can cause flash overs on the insulators.



Other external causes are traffic accidents, construction works and animals impacting the power lines.

Internal causes of voltage sags can include starting major loads and grounding or wiring problems.

Whether or not a voltage sag causes a problem will depend on the magnitude and duration of the sag and on the sensitivity of your equipment. Many types of electronic equipment are sensitive to voltage sags, including variable speed drive controls, motor starter contactors, robotics, programmable logic controllers, controller power supplies, and control relays. Much of this equipment is used in applications that are critical to an overall process, which can lead to very expensive downtime when voltage sags occur.

PCS100 UPS-I INDUSTRIAL UNINTERRUPTIBLE POWER SUPPLY

The PCS100 UPS-I is a robust single conversion UPS providing continuous current flow to the load during transfer due to the revolutionary high-speed Utility Disconnect and fast PCS100 Inverter technology. The modular

inverter construction and robust Fail-Safe Bypass provides the highest efficiency and system availability. The single conversion design with Coupling Transformer enables simple, low footprint construction with wide range of operation voltages, galvanic isolation of DC Energy Storage system and robustness for industrial loads.



How it works

When the utility voltage is normal, the load is supported directly by the utility.

When a sag, surge or outage occurs, the PCS100 UPS-I immediately transfers the load onto its inverters. Power is provided by battery or Ultracapacitor Energy Storage.

Batteries are typically used to bridge start-up time for generator backup systems where critical applications may be subject to longer supply outages.

Ultracapacitors are ideal for protecting the load from sags and short-term outages or to bridge the switching time to another feeder.

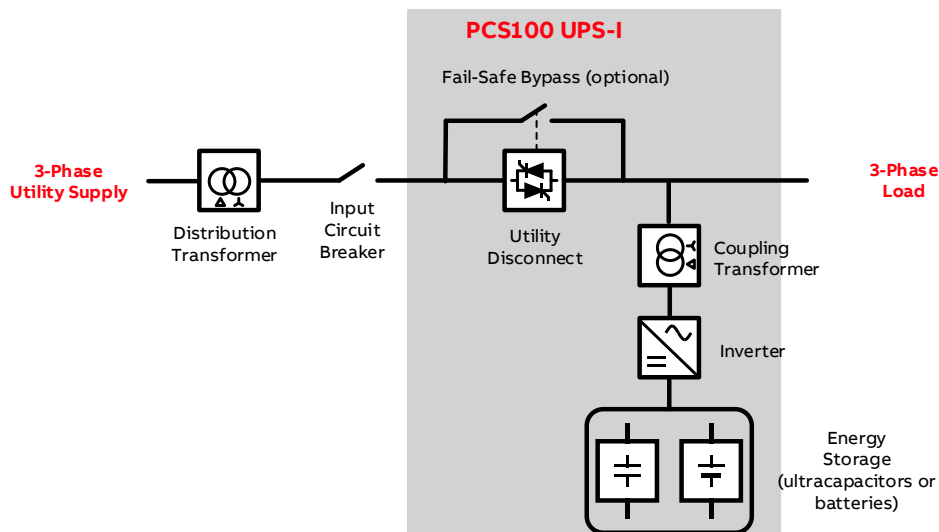

PCS100 UPS-I BENEFITS



Reduce the cost of power quality events

The PCS100 UPS-I closes the electrical compatibility gap between the supply and plant by protecting the load from utility induced voltage sag events, including deep sags.

The PCS100 UPS-I is designed to protect process loads, a perfect solution for industrial loads without having to upsize the system.

Improved plant operation

The PCS100 UPS-I protects the loads from voltage sags in the utility, allowing the facility to continue even when there are disturbances in the utility

voltage. This reduces waste and damage to the expensive equipment.

Use of long lasting ultracapacitor as energy storage, the PCS100 UPS-I has minimum maintenance requirement, achieving minimum interruption to the operation. Built-in redundancy of inverter modules increases availability of the system.

Versatility of installation

The PCS100 UPS-I is a single conversion UPS with high density energy storage. The footprint of the PCS100 UPS-I, is small, meaning it can be installed in areas other solutions cannot.

INDUSTRIES AND APPLICATIONS

Industrial automation has reached very high levels of sophistication. Industrial plants and commercial equipment now use advanced technology, and this technology relies on a robust and continuous power supply. However, the utility grid is susceptible to unpredictable events, such as lightning strikes and faults, resulting in voltage sags.

In the modern industrial world voltage sags cause disturbances in process and product defects. This results in wasted material, long restart times,

extensive repair or maintenance activities, revenue losses or contractual penalties.

The costs of such events can quickly amount to hundreds of thousands of dollars.

Nowadays, almost all continuous production lines and process industries or sensitive medical equipment must perform faultlessly on a continuous basis. Ensuring that equipment receives a stable, clean, continuous flow of power, even during major grid disturbances, is where the PCS100 UPS-I comes in.

PCS100 UPS-I provides power protection of commercial and industrial loads

Electronics industry

Sensitive machinery
Clean room control



Food and beverage

High speed bottling
Packaging lines
Dairy processing



Automotive

Welding process
Coating process
Painting process



Continuous process

Fiber production lines
Film production lines
Extrusion process



Pharmaceutical

Batch process
Climate control



Medical

Sensitive medical imaging equipment



PCS100 UPS-I VALUES



Very high efficiency

Typically, greater than 99%, even on partial loading. The PCS100 UPS-I is an industrial single conversion UPS. It remains inactive unless the voltage swells or sags outside of a user set window.

Small footprint

Single conversion UPS topology does not require rectifiers in the system. Furthermore, use of advanced ultracapacitor or high discharge rate battery storage further assists in reducing the footprint of the system.

Specifically designed for industrial loads

The PCS100 UPS-I is specifically designed for industrial loads such as motors, drives, transformers and tools.

With high overloadability of the system the PCS100 UPS-I does not require unnecessary upsizing to cater for industrial loads, which is often required for IT-purpose double conversion UPS.

Very high fault current capacity

Up to 65 kA (model specific) to ensure that the PCS100 UPS-I can ride through in case of a fault.

Graphical touch screen interface

Simple user controls, easy to understand event log and voltage event data logging

Modular design

Provides high reliability and low MTTR (mean time to repair), 30 minutes or less.

Generator walk-in algorithm

Controlled transfer of the load to backup generators to avoid backup generators tripping.

Wide power and voltage range

Ratings from 150 kVA to 3000 kVA and voltages 208 V_{AC} to 480 V_{AC}.

Connectivity

Ethernet
Modbus TCP
E-mail notifications

Modular construction

Proven PCS100 power converter platform, with more than 1900 MVA installed base, enabling fast and easy maintenance

Sophisticated control software

Based on 20 years voltage conditioning industry experience

FUNCTIONAL DESCRIPTION

PCS100 UPS-I Operation Details

Operational detail

The following diagrams show how the PCS100 UPS-I behaves when a utility disturbance occurs, and what happens when the Fail-Safe Bypass is operating. Note that the following diagrams show a Fail-Safe Bypass. In some PCS100 UPS-I models the Fail-Safe Bypass is integrated and for other models it is optional.

Utility voltage close to nominal level

Power to the load is supplied from the utility (Online mode). Inverters are off but maintain synchronization with the utility voltage to allow instant operation in the case of a utility disturbance. A Float Charger (not shown) maintains the state of charge of the battery or ultracapacitor storage.

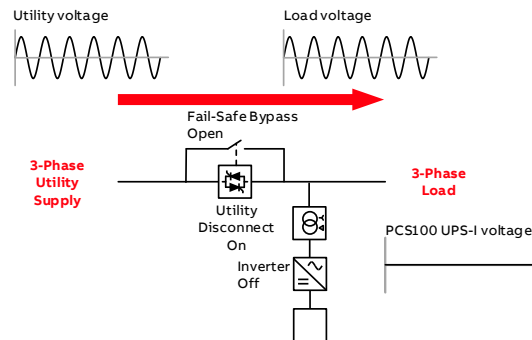

Utility disturbance occurs

When the utility voltage deviates from user defined limits due to voltage sags, surges, under-voltages, over-voltages or outage, the PCS100 UPS-I Inverters are started to begin supplying power to the load (Discharge mode). At the same time, the utility is disconnected isolating the PCS100 UPS-I output and load from the utility. ABB's own inverter commutation technique is used to ensure the Utility Disconnect SCR's are commutated off as fast as possible, minimizing any disturbance to the load

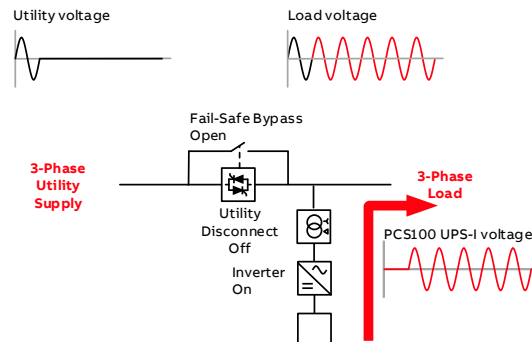

Utility returns

When the voltage returns within user defined limits the PCS100 UPS-I synchronizes with the utility voltage then closes the Utility Disconnect. If required, the PCS100 UPS-I can softly transfer the load from the inverter to the utility or generator using a generator walk-in function. Once the load is transferred power to the load is again supplied by the utility. The PCS100 UPS-I energy storage is then rapidly recharged by the inverters.

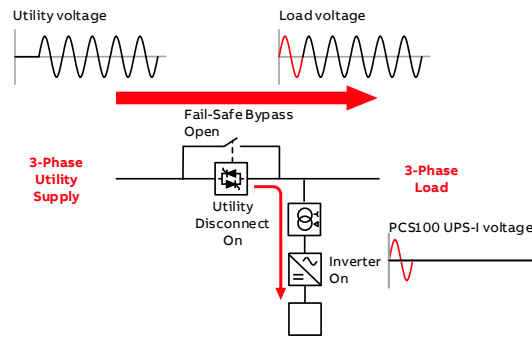

Fail-Safe Bypass operation

In an expected or unexpected PCS100 UPS-I shutdown, load current will be transferred to the Fail-Safe Bypass (where fitted). This provides an additional level of security by placing a mechanical contact in parallel with the Utility Disconnect.

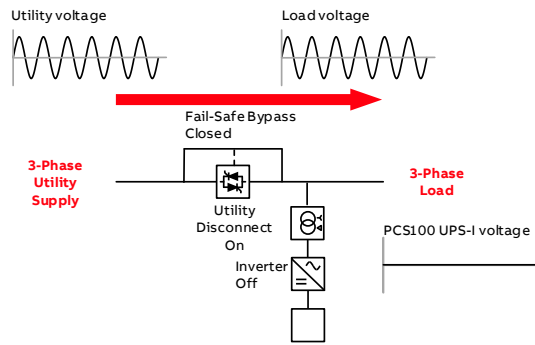

TRANSFER FUNCTION

As a single conversion type UPS the PCS100 UPS-I will transfer the load from the utility supply to the backup energy storage if it detects a deviation of the supply voltage from the nominal value by more than that set by the PCS100 UPS-I set points.

The PCS100 UPS-I is classified as VFD SX 211 for rated powers below 450 kVA and VFD SS 211 for rated powers above 450 kVA according to IEC 62040-3.

According to this classification, the PCS100 UPS-I complies with Classification 2 (211) performance for change of operating mode from utility supply mode to energy storage mode.

The transfer from utility supply mode to energy storage mode is done by closing the Utility Disconnect which consists of a naturally commutated SCR based electronic switch.

A SCR (thyristor) is a naturally commutated device that turns off at the next zero crossing, which could be as long as 10 milliseconds later, and this presents

problem when the need arises to immediately transfer the load at any point in the cycle, i.e. to achieve transfer performance according to IEC 62040-3 Classification 2.

When turning off the Utility Disconnect, the PCS100 UPS-I utilizes revolutionary PCS100 Inverter commutation capability techniques to force the current in the Utility Disconnect and turn SCRs off with typical transfer time of 1.8 milliseconds, resulting the minimum load voltage disturbance.

Without PCS100 Inverter commutation the Utility Disconnect SCRs would continue to conduct until the current naturally decays in next zero crossing which may take up to ½ of a cycle.

The following image shows a typical waveform of the PCS100 UPS-I output voltage during transfer from utility supply to energy storage mode.

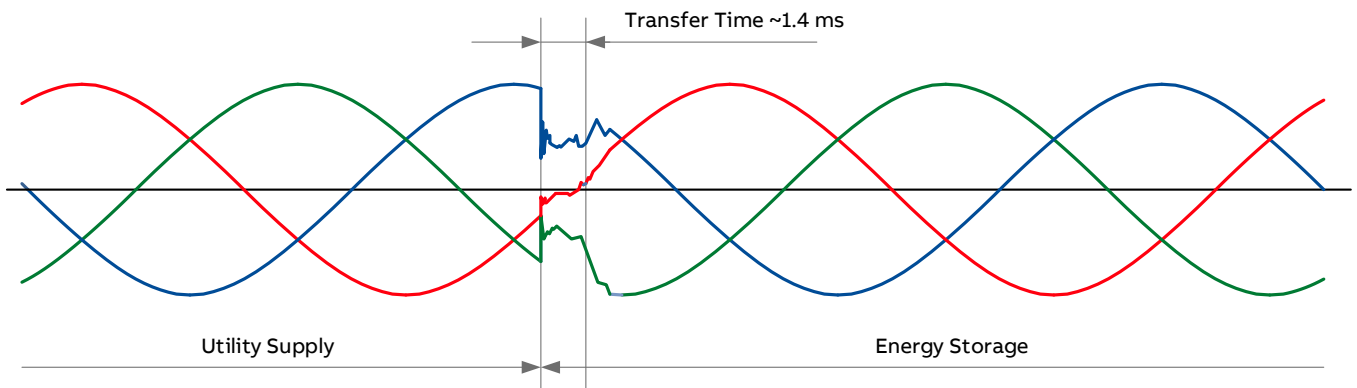

Following diagram shows IEC 62040-3 tolerance curves of each classification and the curve of typical PCS100 UPS-I transfer performance curve.

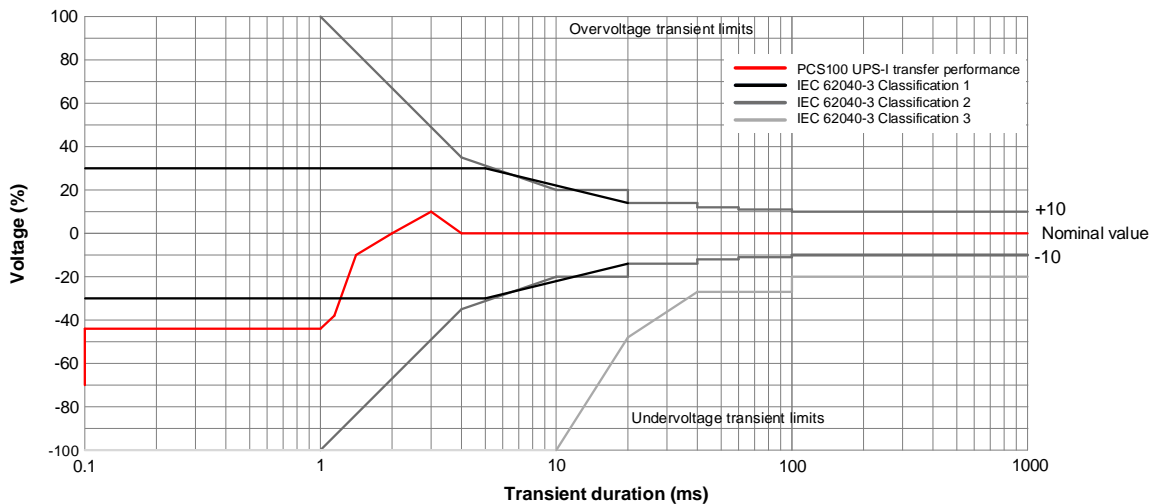

Generator walk-in

The PCS100 UPS-I with Battery Energy Storage with 30 seconds autonomy is typically used to bridge start-up time for stand-by generator backup systems where critical applications may be subject to longer supply outages.

If a stand-by generator is included in the installation it is connected to the Automatic Transfer Switch (ATS). Generally, the stand-by generator is started automatically in the event of a utility supply failure. The Automatic Transfer Switch transfers to the generator when it detects that the generator voltage is stable. When the utility supply is restored, the ATS disconnects stand-by generator and reconnects utility supply.

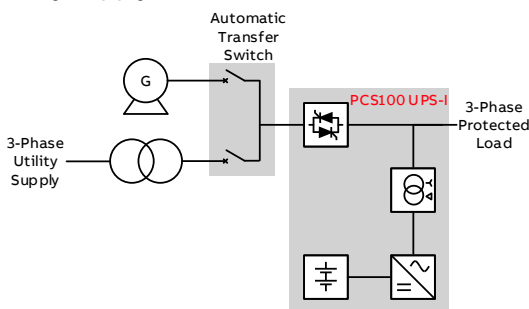

The PCS100 UPS-I needs to support the need to transfer load back to a generator supply from the energy storage mode of operation. However, a step

transfer of load to generator (or weak utility supply networks) will result in the voltage and/or frequency disturbance on the generator terminals exceeding the transfer threshold. The result would be a transfer back to the stored mode.

The Generator Walk-in function of the PCS100 UPS-I supports controlled transfer of the load to stand-by generators. The transfer to the generator will be made when the generator voltage has been stable and within the acceptable bounds as defined by the voltage event criteria. Then the inverter will synchronize to the generator supply and continue to support the load. A linear ramp is imposed on the set-points, ramping the support to generator to zero over a defined time (up to 8 seconds). Once the ramp down is complete the walk-in process is complete and the PCS100 UPS-I reverts to charging mode.

The transfer sequences utility supply – energy storage – generator – energy storage - utility supply are fully automatic and the transfers.

The following image shows the timing diagram of the PCS100 UPS-I Generator Walk-in functionality in the common stand-by generator back-up system with an automatic transfer switch. It can be seen that the load supply is not affected in any case.

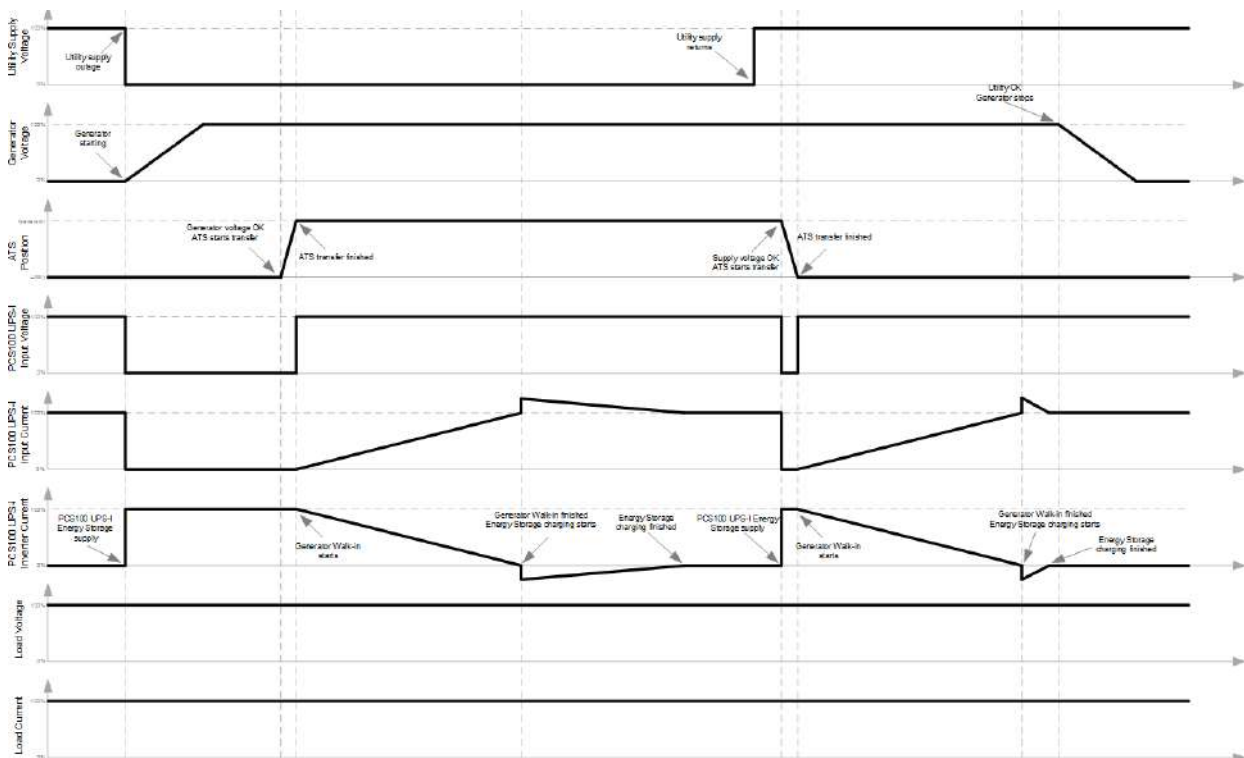

SUBASSEMBLIES

The PCS100 UPS-I consists of the following subassemblies:

- A Utility Disconnect that disconnects the utility supply during a disturbance
- Inverters that convert energy storage DC energy to 3-phase AC power
- Float Charger to charge the energy storage when the utility is operating normally
- A Fail-Safe Bypass to automatically bypass the PCS100 UPS-I when a fault occurs
- Note: The Fail-Safe Bypass is optional in some models
- A Coupling Transformer to match the inverter output with the nominal utility voltage.
- Energy Storage (ultracapacitor or battery) that supplies power to the load during a utility disturbance

Utility Disconnect

The Utility Disconnect is an electronic switch that is used to rapidly disconnect the utility supply from the load if the supply falls out of tolerance.

The Utility Disconnect consists of a naturally commutated SCR based electronic switch augmented with ABB's revolutionary inverter commutation capability which can disconnect the load from the utility in typically 1.8 ms.

When the utility voltage is within specification the Utility Disconnect is closed and the load is supplied from the utility.

This is known as 'online mode'. When the utility voltage is outside specification, the Utility Disconnect is opened, disconnecting the utility from the load. The load is then supplied by the inverter from the energy storage.

There are three sizes of Utility Disconnect:

- 900 A
- 2200 A
- 4200 A

The 900 A Utility Disconnect is module based and is installed in the Inverter Enclosure



The 2200 A and 4200 A Utility Disconnects are separate enclosures that also include the main input and output terminals for connecting the PCS100 UPS-I to the utility and load.

Inverter Modules

The PCS100 UPS-I Inverter modules are IGBT based power electronics modules rated at 150 kVA.

These inverter modules include a sine filter and RFI filters as part of the assembly, meaning the power electronics, sine filter and RFI filters are integrated into one module.

The inverter modules supply high quality sinusoidal power to the load.

In addition to converting DC storage voltage to the AC voltage required by the load, the inverter modules quickly re-charge the energy storage after a power quality event such as a surge, sag or outage.

Depending on requirements, between one and twenty ABB PCS100 Inverter modules are used.



Advanced redundancy

The PCS100 UPS-I inverter consists of multiple 150 kVA PCS100 Inverter modules connected in parallel. If one module fails, the PCS100 UPS-I will automatically reconfigure during stand-by or while supporting the load to operate with the remaining modules.

For example, a six inverter PCS100 UPS-I system offers 900 kVA for normal load protection. If one module fails, the maximum system capacity will be reduced to 750 kVA, and the PCS100 UPS-I Graphic Display Module (GDM) will indicate system availability of 83%. A maximum of 50% of modules may fail before the PCS100 UPS-I will trip.

Inverter Enclosure

The Graphical Display Module (GDM) is always mounted in the door of the Master Inverter Enclosure. The GDM is the PCS100 UPS-I's HMI. The Inverter Enclosure can hold up to six inverters. Where the PCS100 UPS-I requires more than six inverters, two or more enclosures will be required. One enclosure is deemed the Master Inverter Enclosure and the remaining are deemed Slave Inverter Enclosures.

The Master Inverter Enclosure also houses the Auxiliary Master Module which controls all inverters and co-ordinates the actions of the Utility Disconnect and the Fail-Safe Bypass. It also provides communication functionality to the PCS100 UPS-I's GDM and external serial networks. The Slave Inverter Enclosure houses an Auxiliary Slave Module which contains a power supply

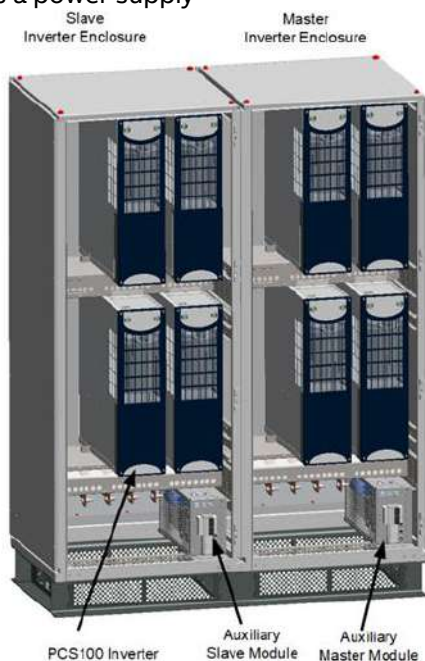

Float Charger

While the inverters provide fast replenishment of energy following a power quality event, a dedicated Float Charger is used for float charging to optimize

energy efficiency. The Float Charger also allows ultracapacitor based systems to start from a completely discharged state.

Coupling Transformer

The Coupling Transformer Enclosure houses the Coupling Transformer and various protection and measuring devices. The transformer consists of delta connected primary and star connected secondary.

The Coupling Transformer has 3 main purposes:

- Transforms inverter output voltage to match the utility voltage.
- Transforms the 3-wire inverter voltage into a 4-wire utility voltage
- Provides galvanic isolation of the PCS100 Inverter system and DC Energy Storage inverter common from the utility.

Fail-Safe Bypass

The Fail-Safe Bypass provides an additional level of security by providing an alternative current path in the event of an expected or unexpected PCS100 UPS-I shutdown.

The Fail-Safe Bypass is a highly automated and coordinated option which provides a degree of extra security against PCS100 UPS-I failure.

Note that the Fail-Safe Bypass does not isolate the PCS100 UPS-I for maintenance or service works. ABB recommend installation of a maintenance bypass for this purpose.

Integrated Fail-Safe Bypass

The PCS100 UPS-I with 900 A Utility Disconnect has an integrated Fail-Safe Bypass.

Optional Fail-Safe Bypass

For PCS100 UPS-I with a Utility Disconnect rated at 2200 A and 4200 A, the Fail-Safe Bypass is optional and supplied in its own enclosure.

If a Fail-Safe Bypass is fitted to a PCS100 UPS-I the customer utility and load terminals are contained within the Fail-Safe Bypass enclosure.

External Fail-Safe Bypass

When the Fail-Safe Bypass option is not selected it is highly recommended to implement the Fail-Safe Bypass functionality into the maintenance bypass to ensure continuity of supply to the load.

External implementation of the Fail-Safe Bypass supports critical functionality. Some features of the optional Fail-Safe Bypass are not supported because they are not as closely coupled to the PCS100 UPS-I system.

For more information on external Fail-Safe Bypass implementation refer to document 2UCD120000E015 Bypass Trigger for PCS100 UPS-I Maintenance Bypass

ENERGY STORAGE

ABB offers the following energy storage systems:

- Ultracapacitors
- Valve-Regulated Lead-Acid (VRLA) batteries.

Ultracapacitor Energy Storage is ideal for protecting the load from frequent sags, swells and short-term outages or to bridge the switching time to another feeder.

Battery Energy Storage is typically used to bridge start-up time for generator backup systems where critical applications may be subject to longer supply outages.

The energy storage required depends on the output required by the load (the load's kW rating), and the autonomy period (seconds). The autonomy period is the period the PCS100 UPS-I can supply rated load from its energy storage. The required number of enclosures increases with the PCS100 UPS-I rating and autonomy period. The energy storage enclosures each include their own DC circuit protection.

Ultracapacitor Energy Storage



Ultracapacitor Energy Storage consists of one or more 300 kW ultracapacitor strings. A 300 kW string consists of ultracapacitor modules connected in series to a voltage of 750 VDC. Multiple strings are connected in parallel for increased kW or autonomy (ride through) time. The autonomy time is typically 2 to 3 seconds at rated kVA and 0.8 PF when the ultracapacitors are new. Some models have different autonomy due to storage medium rationalization. An Ultracapacitor Energy Storage enclosure can contain 1 or 2 ultracapacitor strings. Each string is protected by its own main DC circuit breaker and separate charger fuses.

Ultracapacitor Monitor Board

Each Ultracapacitor Energy Storage enclosure includes an Ultracapacitor Monitor Board that is monitoring all relevant information inside the enclosure:

- Status of all the ultracapacitors per string (overvoltage and overtemperature)
- Incoming DC voltage
- DC voltage of each ultracapacitor string
- DC circuit breaker status
- Enclosure internal temperature

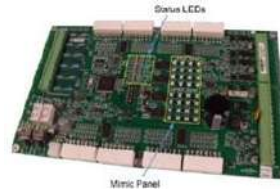

In case of a fault in any of the ultracapacitor modules or enclosures, the Ultracapacitor Monitor Board automatically takes the appropriate action, which may be a warning or if necessary, isolation of the string with the faulty module. Non-faulty string operation is not affected. In any event a warning is issued on the PCS100 UPS-I GDM and service personnel can determine the cause of the warning by inspecting the Monitoring Board.

The Ultracapacitor Monitor Board includes two levels of HMI for information:

- Two Status/Reset lamps on the front door for general information on status of each string
- Mimic panel and status LEDs on the Ultracapacitor Monitor Board inside the enclosure give additional information on the status of each ultracapacitor module and the complete Energy Storage Enclosure

Ultracapacitor Energy Storage features:

- Single string maximum rating is 300 kW for 2 seconds when the ultracapacitors are new.
- Multiple ultracapacitors are connected in series to form a 750 VDC string (+/- 375 VDC).
- 1 or 2 strings per enclosure, each individually protected.
- Design life: 15 years @ 25 °C.
- Very high cycle life: >500,000.
- High discharge efficiency.
- Ultracapacitor module balancing.
- Extensive monitoring and protection.
- Safe and compact matching enclosure.
- Very low maintenance.
- Very small footprint.

Battery Energy Storage

Battery Energy Storage consists of one or more 240 kW battery strings. A 240 kW string consists of 56 Valve-Regulated Lead-Acid (VRLA) batteries connected in series to a voltage of 780 VDC. Multiple strings are connected in parallel for increased kW or autonomy (ride through) time. The autonomy time is typically 30 seconds at rated kVA and 0.8 PF. A single Battery Energy Storage enclosure contains 1 battery string.

Battery Energy Storage features:

- VRLA single string maximum rating is 240 kW for 30 seconds when the batteries are new.
- 56 batteries are connected in series to form a 780 VDC string (+/- 390 VDC)
- 1 string per enclosure, individually protected
- Design Life: 10 years @ 25 °C
- Cycle life: >800
- Very high discharge capability

- Safe and compact matching
- Low maintenance
- Small footprint

Models without Batteries

The PCS100 UPS-I can be supplied without batteries from the factory.

Empty battery enclosures can be ordered to fit ABB specified batteries.

Third-party sourced batteries may be used; however, battery systems must meet ABB's battery performance and protection requirements. For information on these requirements, refer to ABB document 2UCD120000E013.



TECHNICAL SPECIFICATION

Utility - Input

Rated voltage	220 V – application range 208 – 220 V 400 V – application range 380 – 400 V 480 V – application range 415 – 480 V
Voltage tolerance	±10%
Nominal supply frequency	50 or 60 Hz
Frequency tolerance	±5 Hz
Maximum continuous voltage	110%
Power system ¹	3-phase + neutral (4-wire) center ground reference (TN-S)
Overvoltage category	III
Fault capacity	Refer to the model tables in this catalogue
Efficiency	99% (typical) – 400 & 480 V models 98% (typical) – 220 V models
Overload and short circuit protection	Circuit breaker (not included)
Overload capacity ²	120% for 60 s 150% for 30 s 200% for 10 s 300% for 5 s
Harmonics ³	IEC 61000-2-4 Class 2 (THD _v < 8%)

Load - Output

Rated power	150 to 3000 kVA
Displacement power factor of connected load	0.5 lagging to 0.9 leading
Crest factor for rated kVA	2.0
Maximum allowed regenerative load ⁴	25% of rated kVA

Inverter supply

Maximum operating period	30 s at 100% rated capacity
Transfer time	≤ 1.8 ms (typical)
Voltage settling time	≤ 5 ms (typical)
Cooling	Forced ventilation
Minimum output voltage	> 95% at end of discharge
Output frequency	50 or 60 Hz, matching the supply frequency
Frequency accuracy	0.1%
Overload capacity	110% for 30 s
Voltage distortion	< 2.5% THD _v for linear loads
Voltage unbalance	< 3% for 100% unbalanced loads
Fault capacity (short circuit)	120% of rated current

Fail-Safe Bypass

900 A Utility Disconnect	Integrated normally closed contactors
2200 & 4200 A Utility Disconnect	Optional air circuit breaker (ACB)

¹ For use in other power systems refer to 2UCD120000E017

² Not more than once every 10 minutes. For more information refer to the Input Circuit Protection section of this catalogue

³ For THD_v > 8%, please refer to factory. For applications where THD_v is above 10% lifetime of components may be significantly affected, please refer to factory

⁴ Contact ABB for applications with greater than 25%

Overload capacity ⁵	150% for 500 s 200% for 300 s 300% for 120 s 500% for 30 s
Closing time 900 A 2200 & 4200 A	20 ms 80 ms
Cooling	Natural convection
Coupling Transformer	
Capacity rating	110% of PCS100 UPS-I kVA rating for 30 s
Type	Dry
UL insulation class	N (200 °C)
Design temperature	Temperature rise 60 °C for short term full load operation
Typical impedance ⁶	8%
Energy Storage - Ultracapacitors	
Nominal DC voltage	750 VDC
Discharging voltage range	750 to 554 VDC
Overload capacity	100%
Rated power	300 kW per string
Autonomy period ⁷	2 s @ 300 kW
Operating temperature	15 to 25 °C recommended
Design life	15 years at 25 °C
Cycle life	> 500,000
Recharge time	< 45 s
Energy storage - Batteries	
Nominal DC voltage	672 V (56 × 12 VDC)
Discharging voltage range	780 to 554 VDC
Overload capacity	100%
Rated power	240 kW per string
Autonomy period ⁷	30 s @ 240 kW
Operating temperature	15 to 25 °C recommended
Design life	10 years at 25 °C
Cycle life	> 800 (full load 30 s discharge)
Recharge time	< 30 min
Event Recording	
Measurement method	Line to line
Sample time	125 μs
Resolution of time stamp in event log	10 ms
Measurement type	Half-cycle RMS according to IEC 61000-4-30
Environmental	
Operating temperature range	0 to 40 °C 32 to 104 °F
Operating altitude	< 1000 m without derating
Capacity derating with altitude	1% every 100 m above 1000 m, 2000 m maximum
Humidity	< 95%, non-condensing
Pollution degree rating	2

⁵ Not more than once every 30 minutes

⁶ The PCS100 UPS-I incorporates impedance voltage compensation control methods

⁷ For more information refer to the autonomy calculations in this catalogue

Noise	< 75 dBA @ 2 m
Enclosure	
Enclosure rating	IP20/NEMA 1
Material	Electrogalvanized steel
Panel thickness	
Side and rear	1.5 mm
Door	2 mm
Finish	Standard epoxy-polyester powder coating textured finish
Color	RAL 7035
Enclosure access	Hinged door with key lock
User Interface	
User interface	10.1" color touch panel
Touch panel	Full parameter control
Control inputs	Start / Stop / Reset digital inputs
Control outputs	Running / Warning / Fault relays
Serial Communications	
Access protocol	Ethernet connectivity, Modbus TCP
Standards and Certifications	
Quality	ISO 9001
Marking	CE, C-Tick
Construction and safety	IEC 62040-1, IEC 62477-1
Electromagnetic compatibility	IEC 62040-2, Category C3
Performance	IEC 62040-3, VFD SX 211 ≤ 450 kVA, VFD SS 211 > 450 kVA

HOW TO SELECT A PCS100 UPS-I

To select the correct size of the PCS100 UPS-I for the application the following information should be known.

Utility voltage

Power rating of the load (kVA and kW, or kVA and power factor)

The product tables in the following section can then be used to look up the required model for the given application. Each model has a specific type code.

Type Code

The PCS100 UPS-I type code is given in the product tables. The type code is a unique code for the specific PCS100 UPS-I model and specifies all the components that are used to construct the model. From the base code given in the product tables options can be added to the type code. These options are called plus (+) codes.

The following diagram outlines the structure of the type code:

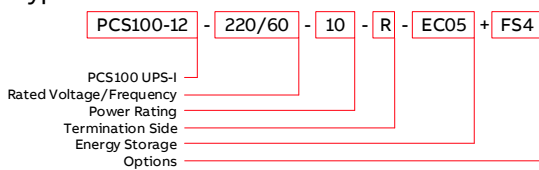

Type Code Parameters:

Rated Voltage/Frequency

This is the rated voltage of the PCS100 UPS-I. Options are 480 V, 400 V and 220 V. Other operating voltages (e.g., 380 V) are achieved by software settings and setting of an auxiliary transformer tapping. Frequency refers to the utility frequency.

Power Rating

Rated power of the system is based on the number of inverter modules, denoted in the type code. Each inverter operating on rated voltage provides 150 kVA of power.

Calculation of Autonomy Period at Specific Load levels

The autonomy period for a load level other than those given in the tables can be calculated using the following information and graphs.

Example:

Application's requirements	
Load	500 kVA
Power Factor	0.9
Supply	400 V, 50 Hz
Storage autonomy	Short time autonomy

Termination Side

The location of the power terminals (input and output) when viewed from the front of the Utility Disconnect. Note that the termination side is determined by the size of the UD and is not user selectable.

Energy Storage

Both type of energy storage and number of strings is defined. For example, EC01 reflects 1 string of ultracapacitor storage while EB04 refers to 4 strings of battery energy storage.

Options

Options as described in this catalogue are then added as plus codes to the main type code.

PCS100 UPS-I Sizing Tool

In addition, ABB provides a Windows PC application PCS100 UPS-I Sizing Tool that can be used to dimension the correct PCS100 UPS-I model required for the application.

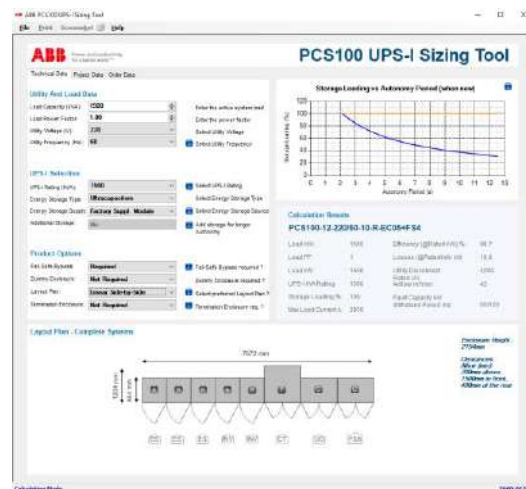

For further information and tool availability please contact your local ABB sales office.

To use the Storage Loading vs. Autonomy Period graph below the Relative Loading (%) of the energy storage must be calculated.

PCS100 UPS-I model Selection

Based on application load requirements and PCS100 UPS-I ultracapacitor model tables, the closest larger kVA rating PCS100 UPS-I model can be selected.

400 V Ultracapacitor Models

Rated power kVA @ 400 V	Rated power kVA @ 380 V	Autonomy time Sec (Rated kVA @ 0.8PF)	Autonomy time Sec (Rated kVA @ 1.0PF)	Inverter Rated Current A	Inverters	Utility Disconnect Rated Current	Terminal Position	Losses kW (typical)	Efficiency % (typical)	Airflow (m ³ /min) Standby	Fault Capacity (Icw) kA / Withstand Period ms	Frame Size		Type Code
												PCS100 UPS-I	Energy Storage	
150	143	8	6.5	217	1	900	L	2.3	98.5	27	25 / 10	1xB	1xA	PCS100-12-400/50-01-L-EC01
300	285	3	2	433	2	900	L	3.3	98.9	27	25 / 10	1xB	1xA	PCS100-12-400/50-02-L-EC01

Application Active Load Calculation

First it is necessary to determine kW rating of the load. Either take directly the load kW if known or

multiply the load kVA by the provided power factor to determine the load kW.

Active load calculation

Load kW	500 kVA x 0.9	450 kW
---------	---------------	--------

Energy Storage Rating Determination

In this step it is necessary to determine number of ultracapacitor strings based on the active load requirements.

Ultracapacitor Energy Storage is based on parallel connection of ultracapacitor strings. The number of parallel connected ultracapacitor strings is defined in the PCS100 UPS-I Type code (ECxx: where xx

defines number of parallel connected ultracapacitor strings). Storage rating is determined by multiplication of the number of strings of selected PCS100 UPS-I model by 300 kW.

In the selected model with type code PCS100-12-400/50-04-L-EC02 there are 2 ultracapacitor strings.

Energy storage rating

Energy storage rating	300 kW x 2	600
-----------------------	------------	-----

Relative Loading Calculations

Relative Loading can now be calculated by dividing the Load kW by the storage rating.

Relative loading calculation

Relative loading	450 kW / 600 kW	600 75%
------------------	-----------------	---------

Autonomy Determination

The actual autonomy for the selected PCS100 UPS-I model, under the given operating conditions, is determined by reading the information on Storage Loading vs. Autonomy Period graph.

For this example, autonomy can now be found by moving across from the calculated relative loading point (75%) on the Y-axis and reading the autonomy period from the intersection with the curves.

Autonomy period at 75% relative loading

New	3.6 s
After 5 years	3.2 s
After 10 years	2.8 s
After 15 years	2.1 s

The Storage Loading vs. Autonomy Period graph below shows dependency of autonomy period

versus loading of Ultracapacitor Energy Storage at ambient temperatures of 25 °C and below.

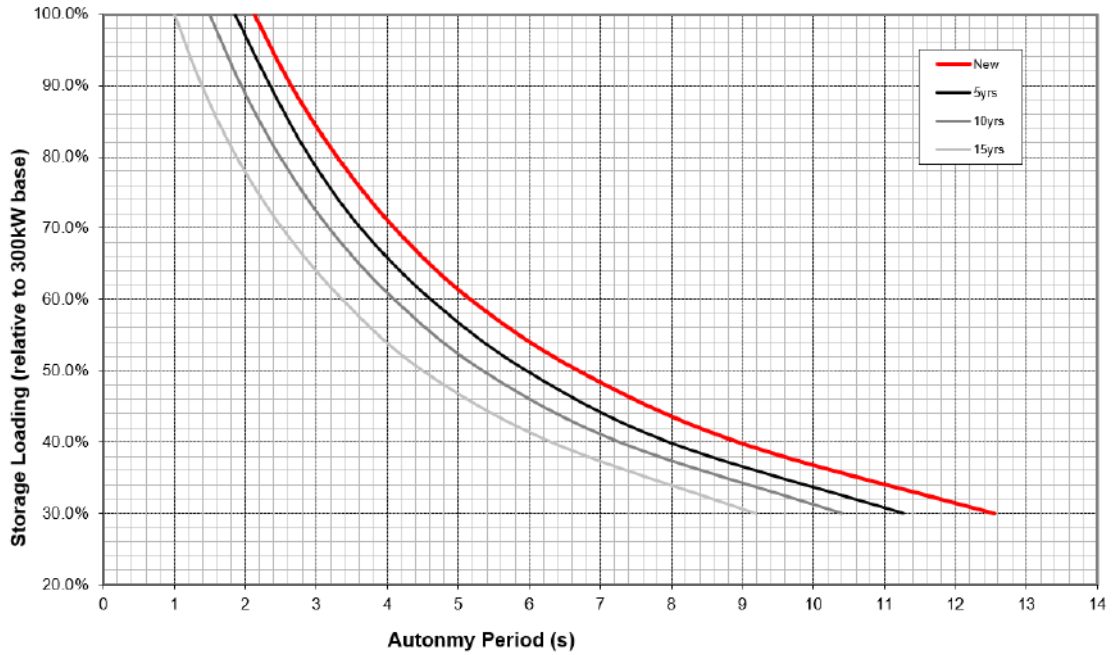

Storage Loading vs Autonomy Period

Note: Care should be taken to ensure the Ultracapacitor Energy Storage enclosure temperature does not exceed 25 °C. The life

expectancy of the capacitors or batteries reduces significantly above 25 °C.

Calculation of Autonomy Period at Specific Load Levels

The autonomy period for battery models at other load levels requires consideration of the relative kVA and kW loading. A full explanation of the calculations needed to determine a battery model autonomy period is given in ABB Document 2UCD120000E018

PCS100 UPS-I and system derating for extended autonomy (30-300 seconds).

Note: Complete calculation of autonomy period at specific load levels, with additional features, is implemented in the PCS100 UPS-I Sizing Tool.

ADVANCED FUNCTIONALITY

Voltage Event Detection

The PCS100 UPS-I is classified as a single conversion UPS of the type VFD according to IEC62020-3. That is, the voltage and frequency are protected but are dependent on the supply in normal operation.

In the event of a power quality event on the utility supply the PCS100 UPS-I will transfer the load to the backup energy storage via an inverter.

The PCS100 UPS-I incorporates the advanced critical Voltage Event Detector control block with a function to identify when to transfer the load off the utility supply voltage (Online mode) and on to the inverter system (Discharge mode). This must be done quickly to limit the exposure of the load to out of tolerance voltage but should not be so sensitive to normal utility supply disturbances such as switching transients, background voltage harmonics or events caused by the load cause unnecessary transfers. Excessive transfers to the inverter and energy storage supply should be avoided as these can shorten the life of the energy storage element, create additional disturbance, and leave the energy storage in a state where it is not prepared (charged) to manage a true event.

The PCS100 UPS-I Voltage Event Detection is a combination of two complementary voltage event detection methods targeting different voltage event characteristics:

- RMS detector
- Transient detector
- Frequency detector

RMS Detector

The RMS detector is a slow response detection based on the deviation of the utility supply RMS voltage from the supply voltage set point.

This method is sensitive to half-cycle voltage changes and will reject harmonic voltage deviations apart from their minor impact on the total RMS value.

The RMS detector is responsible for detecting the smaller sag, surge, overvoltage and undervoltage events but is insensitive to phase changes.

Transient Detector

The Transient detector is a fast response detection based on the deviation of the utility supply instantaneous voltage from the instantaneous value of the voltage set point. It monitors the instantaneous three phase voltage vector and compares it with an ideal voltage vector which is phase locked to the historical utility supply voltage. This detector is sensitive to large momentary voltage disturbances like deep sags and surges, outages and phase jumps and is the primary mechanism used to rapidly initiate a PCS100 UPS-I transfer when a major voltage event occurs.

To prevent false transfers occurring due to harmonic distortion or switching transients on the supply the transient detector is carefully optimized.

In addition, the PCS100 UPS-I incorporates a source impedance voltage drop compensation which ameliorates harmonic voltage disturbance at the point of coupling which is commonly caused by the connected load causing voltage drops across the supply impedance.

Frequency Detector

The frequency detection is based on the deviation of the supply frequency from the supply frequency set point. Frequency detection typically is only used on supplies where the frequency can vary widely.

The default parameters have been chosen carefully to balance the need for rapid response to real events against the desire to reject nuisance disturbances. The default voltage event detection response is shown in the following curves.

Four curves are shown in each of the figures. The 100% Un represents the curve when the historical voltage was at the nominal value for the supply. The 90% Un and 110% Un represent the condition where the historical voltage was 10% below and 10% above the nominal voltage. The IEC62040-3 limit is a reference baseline curve and represents the curve required to meet the IEC62040-3 UPS standards for Classification 2 with 0.5 ms allowance for transfer to the inverter operation.

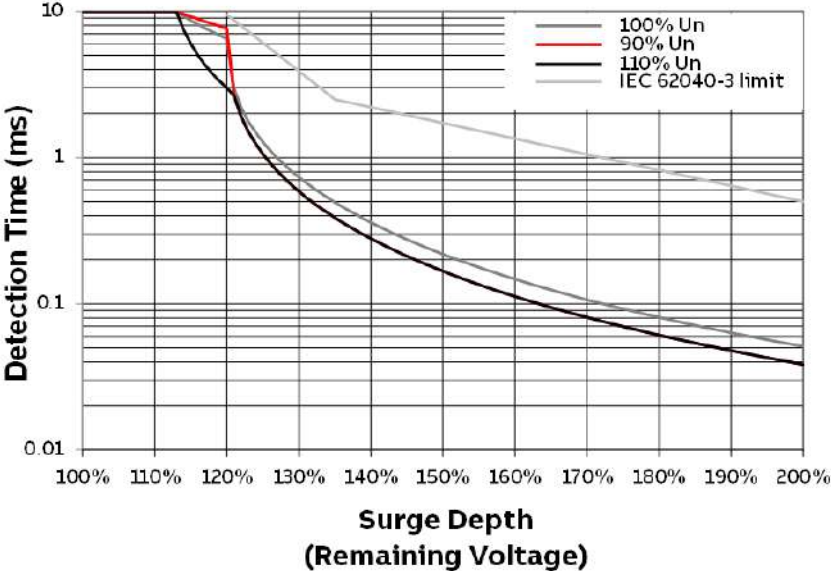
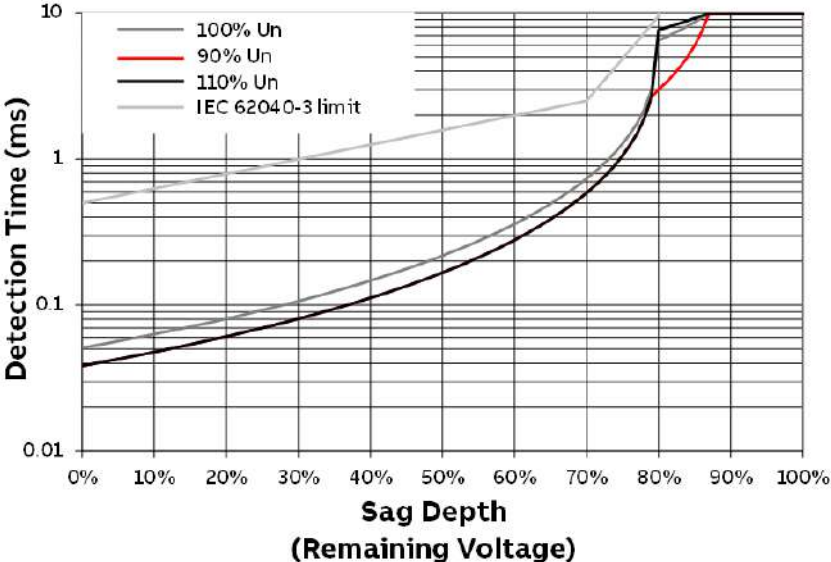

ULTRACAPACITOR MODELS

The following tables give the models available with Ultracapacitor Energy Storage. For certain power ratings there are two different models shown. The difference is in the number of capacitor strings and resulting autonomy period. Autonomy time is given

for 0.8 Power Factor (PF) and 1.0 PF. Certain power ratings show a dash (-) under the 1.0 PF autonomy column. These models are rated for 0.8 PF maximum, if higher power factor is required the next model size up should be used.

220 V Ultracapacitor Models

Rated power kVA @ 220 V	Rated power kVA @ 208 V	Autonomy time Seconds (Rated kVA @ 0.8PF)	Autonomy time Seconds (Rated kVA @ 1.0PF)	Inverter Rated Current A	Inverters Quantity	Utility Disconnect Rated Current A	Terminal Position (Utility & Load)	Losses kW (typical)	Efficiency % (typical)	Airflow (m ³ /min) Standby	Fault Capacity (Icw) kA / Withstand Period ms	Frame Size		Type Code
												PCS100 UPS-I	Energy Storage	
150	142	8	6.5	394	1	900	L	2.9	98.0	27	25 / 10	1xB	1xA	PCS100-12-220/x0-01-L-EC01
300	284	3	2	787	2	900	L	4.8	98.4	27	25 / 10	1xB	1xA	PCS100-12-220/x0-02-L-EC01
450	425	5	3.5	1181	3	2200	R	6.7	98.5	35	50 / 120	2xA 1xC	1xA	PCS100-12-220/x0-03-R-EC02
600	567	3	2	1575	4	2200	R	8.9	98.5	35	50 / 120	1xA 2xC	1xA	PCS100-12-220/x0-04-R-EC02
750	709	2	-	1968	5	2200	R	11.0	98.5	35	50 / 120	1xA 2xC	1xA	PCS100-12-220/x00-5-R-EC02
750	709	4	3	1968	5	2200	R	11.0	98.5	35	50 / 120	1xA 2xC	2xA	PCS100-12-220/x0-05-R-EC03
900	851	3	2	2362	6	4200	R	11.8	98.7	45	65 / 120	1xA 2xC	2xA	PCS100-12-220/x0-06-R-EC03
1200	1135	3	2	3149	8	4200	R	15.7	98.7	45	65 / 120	2xA 2xC	2xA	PCS100-12-220/x0-08-R-EC04
1500	1418	2	-	3936	10	4200	R	19.8	98.7	45	65 / 120	2xA 1xC 1xF	2xA	PCS100-12-220/x0-10-R-EC04
1500	1418	3	2	3936	10	4200	R	19.8	98.7	45	65 / 120	2xA 1xC 1xF	3xA	PCS100-12-220/x0-10-R-EC05

Note:
208 V operation is achieved by setting a 220 V PCS100 UPS-I to 208 V. This configuration is done at the factory and must be specified at when ordering.

Note:
Frame Size shown in the table defines standard PCS100 UPS-I in linear side-by side layout only. It does not include optional Fail-Safe Bypass enclosure or dummy enclosure options. If needed, for Fail-Safe Bypass enclosure please add additional 1xC enclosure for PCS100 UPS-I with load current greater than 900 A.

To complete the Type Code:
Place 5 for 50Hz or 6 for 60Hz in place of the X

Nominal ratings

Rated power	Rated power at stated voltage and power factor available from energy storage for defined autonomy time
Inverter Rated Current	Rated inverter current available during PCS100 UPS-I discharge mode
Utility Disconnect Rated Current	Rated UD current during PCS100 UPS-I online mode

Overload ratings

Inverter	110% of rated current for 30 s
Utility Disconnect	120% of rated current for 60 s every 10 minutes 150% of rated current for 30 s every 10 minutes 200% of rated current for 10 s every 10 minutes 300% of rated current for 5 s every 10 minutes

400 V⁸ Ultracapacitor Models

Rated power kVA @ 400 V	Rated power kVA @ 380 V	Autonomy time Sec (Rated kVA @ 0.8PF)	Autonomy time Sec (Rated kVA @ 1.0PF)	Inverter Rated Current A	Inverters Quantity	Utility Disconnect Rated Current A	Terminal Position (Utility & Load)	Losses kW (typical)	Efficiency % (typical)	Airflow (m ³ /min) Standby	Fault Capacity (ICW) kA / Withstand Period ms	Frame Size		Type Code
												PCS100 UPS-I	Energy Storage	
150	143	8	6.5	217	1	900	L	2.3	98.5	27	25 / 10	1xB	1xA	PCS100-12-400/50-01-L-EC01
300	285	3	2	433	2	900	L	3.3	98.9	27	25 / 10	1xB	1xA	PCS100-12-400/50-02-L-EC01
450	428	5	3.5	650	3	900	L	4.5	99.0	27	25 / 10	1xA 1xB	1xA	PCS100-12-400/50-03-L-EC02
600	570	3	2	866	4	900	L	5.9	99.0	27	25 / 10	1xB 1xC	1xA	PCS100-12-400/50-04-L-EC02
750	709	2	-	1083	5	2200	R	7.1	99.1	35	50 / 120	1xA 2xC	1xA	PCS100-12-400/50-05-R-EC02
750	713	4	3	1083	5	2200	R	7.1	99.1	35	50 / 120	1xA 2xC	2xA	PCS100-12-400/50-05-R-EC03
900	855	3	2	1299	6	2200	R	7.7	99.1	35	50 / 120	1xA 2xC	2xA	PCS100-12-400/50-06-R-EC03
1200	1140	3	2	1732	8	2200	R	10.1	99.2	35	50 / 120	2xA 2xC	2xA	PCS100-12-400/50-08-R-EC04
1500	1425	2	-	2165	10	2200	R	12.6	99.2	35	50 / 120	2xA 1xC 1xF	2xA	PCS100-12-400/50-10-R-EC04
1500	1425	3	2	2165	10	2200	R	12.6	99.2	35	50 / 120	2xA 1xC 1xF	3xA	PCS100-12-400/50-10-R-EC05
1800	1710	2.2	-	2598	12	4200	R	14.3	99.2	45	65 / 120	2xA 1xC 1xG	3xA	PCS100-12-400/50-12-R-EC05
1800	1710	3	2	2598	12	4200	R	14.3	99.2	45	65 / 120	2xA 1xC 1xG	3xA	PCS100-12-400/50-12-R-EC06
2100	1995	2.3	-	3031	14	4200	R	16.7	99.2	45	65 / 120	3xA 1xC 1xG	3xA	PCS100-12-400/50-14-R-EC06
2100	1995	3	2	3031	14	4200	R	16.7	99.2	45	65 / 120	3xA 1xC 1xG	4xA	PCS100-12-400/50-14-R-EC07
2400	2280	2.5	-	3464	16	4200	R	18.9	99.2	45	65 / 120	3xA 1xC 1xG	4xA	PCS100-12-400/50-16-R-EC07
2400	2280	3	2	3464	16	4200	R	18.9	99.2	45	65 / 120	3xA 1xC 1xG	4xA	PCS100-12-400/50-16-R-EC08

⁸ It is possible to supply 400 V, 60 Hz models also. Please contact the factory.

Note:
380 V operation is achieved by setting a 400 V PCS100 UPS-I to 380 V. This configuration is done at the factory and must be specified at when ordering.

Note:

Frame Size shown in the table defines standard PCS100 UPS-I in linear side-by side layout only. It does not include optional Fail-Safe Bypass enclosure or dummy enclosure options. If needed, for Fail-Safe Bypass enclosure please add additional 1xC enclosure for PCS100 UPS-I with load current greater than 900 A.

Nominal ratings	
Rated power	Rated power at stated voltage and power factor available from energy storage for defined autonomy time
Inverter Rated Current	Rated inverter current available during PCS100 UPS-I discharge mode
Utility Disconnect Rated Current	Rated UD current during PCS100 UPS-I online mode
Overload ratings	
Inverter	110% of rated current for 30 s
Utility Disconnect	120% of rated current for 60 s every 10 minutes 150% of rated current for 30 s every 10 minutes 200% of rated current for 10 s every 10 minutes 300% of rated current for 5 s every 10 minutes

480 V Ultracapacitor Models

Rated power kVA @ 480 V	Rated power kVA @ 440 V	Rated power kVA @ 415 V	Autonomy time Sec (Rated kVA @ 0.8PF)	Autonomy time Sec (Rated kVA @ 1.0PF)	Inverter Rated Current A	Inverters Quantity	Utility Disconnect Rated Current (A)	Terminal Position (Utility & Load)	Losses kW (typical)	Efficiency % (typical)	Airflow (m ³ /min) Standby	Fault Capacity (Icw) kA Withstand Period ms	Frame Size		Type Code (To complete the Type Code: Place 5 for 50Hz or 6 for 60Hz in place of the X
													PCS100 UPS-I	Energy Storage	
150	138	130	8	6.5	180	1	900	L	2.3	98.5	27	25 / 10	1xB	1xA	PCS100-12-480/x0-01-L-EC01
300	275	259	3	2	361	2	900	L	3.2	98.9	27	25 / 10	1xB	1xA	PCS100-12-480/x0-02-L-EC01
450	413	389	5	3.5	541	3	900	L	4.3	99.1	27	25 / 10	1xA 1xB	1xA	PCS100-12-480/x0-03-L-EC02
600	550	519	3	2	722	4	900	L	5.5	99.1	27	25 / 10	1xB 1xC	1xA	PCS100-12-480/x0-04-L-EC02
750	688	648	2	-	902	5	900	L	6.6	99.1	35	50 / 120	1xB 1xC	1xA	PCS100-12-480/x0-05-L-EC02
750	688	648	4	3	902	5	900	L	6.6	99.1	35	50 / 120	1xB 1xC	2xA	PCS100-12-480/x0-05-L-EC03
900	825	778	3	2	1083	6	2200	R	7.1	99.2	35	50 / 120	1xA 2xC	2xA	PCS100-12-480/x0-06-R-EC03
1200	1100	1038	3	2	1443	8	2200	R	9.1	99.2	35	50 / 120	2xA 2xC	2xA	PCS100-12-480/x0-08-R-EC04
1500	1375	1297	2	-	1804	10	2200	R	11.2	99.3	35	50 / 120	2xA 1xC 1xF	2xA	PCS100-12-480/x0-10-R-EC04
1500	1375	1297	3	2	1804	10	2200	R	11.2	99.3	35	50 / 120	2xA 1xC 1xF	3xA	PCS100-12-480/x0-10-R-EC05
1800	1650	1556	2.2	-	2165	12	2200	R	13.6	99.2	35	50 / 120	2xA 1xC 1xG	3xA	PCS100-12-480/x0-12-R-EC05
1800	1650	1556	3	2	2165	12	2200	R	13.6	99.2	35	50 / 120	2xA 1xC 1xG	3xA	PCS100-12-480/x0-12-R-EC06
2100	1925	1816	2.3	-	2526	14	4200	R	14.9	99.3	45	65 / 120	3xA 1xC 1xG	3xA	PCS100-12-480/x0-14-R-EC06
2100	1925	1816	3	2	2526	14	4200	R	14.9	99.3	45	65 / 120	3xA 1xC 1xG	4xA	PCS100-12-480/x0-14-R-EC07
2400	2200	2075	2.5	-	2887	16	4200	R	16.6	99.3	45	65 / 120	3xA 1xC 1xG	4xA	PCS100-12-480/x0-16-R-EC07
2400	2200	2075	3	2	2887	16	4200	R	16.6	99.3	45	65 / 120	3xA 1xC 1xG	4xA	PCS100-12-480/x0-16-R-EC08

440V Ultracapacitor Model (Note: This model uses 2 x 440 V, 1.5 MVA transformer)

Rated power kVA @ 480 V	Autonomy time Sec (Rated kVA @ 0.8PF)	Autonomy time Sec (Rated kVA @ 1.0PF)	Inverter Rated Current A	Inverters Quantity	Utility Disconnect Rated Current (A)	Terminal Position (Utility & Load)	Losses kW (typical)	Efficiency % (typical)	Airflow (m ³ /min) Standby	Fault Capacity (Icw) kA Withstand Period ms	Frame Size		Type Code To complete the Type Code: Place 5 for 50Hz or 6 for 60Hz in place of the X
											PCS100 UPS-I	Energy Storage	
3000	3	2	3608	20	4200	R	23.5	99.3	45	65/120	4xA 2xC 2xF	5xA	PCS100-12-440/x0-20-R-EC10

Note:
415 V or 440 V operation is achieved by setting a 480 V PCS100 UPS-I to 415 V or 440 respectively. This configuration is done at the factory and must be specified at when ordering.

Frame Size shown in the table defines standard PCS100 UPS-I in linear side-by side layout only. It does not include optional Fail-Safe Bypass enclosure or dummy enclosure options. If needed, for Fail-Safe Bypass enclosure please add additional 1xC enclosure for PCS100 UPS-I with load current greater than 900 A.

Note:

Nominal ratings

Rated power	Rated power at stated voltage and power factor available from energy storage for defined autonomy time
Inverter Rated Current	Rated inverter current available during PCS100 UPS-I discharge mode
Utility Disconnect Rated Current	Rated UD current during PCS100 UPS-I online mode

Overload ratings

Inverter	110% of rated current for 30 s
Utility Disconnect	120% of rated current for 60 s every 10 minutes 150% of rated current for 30 s every 10 minutes 200% of rated current for 10 s every 10 minutes 300% of rated current for 5 s every 10 minutes

BATTERY MODELS

The following tables give the models available with battery energy storage. Autonomy time is given for 0.8 Power Factor (PF) and 1.0 PF. Certain power ratings show a dash (-) under the 1.0 PF autonomy columns. These models are rated for 0.8 PF maximum if higher power factor is required the next model size up should be used.

220 V Battery Models

Rated power kVA @ 220 V	Rated power kVA @ 208 V	Autonomy time Seconds (Rated kVA @ 0.8PF)	Autonomy time Seconds (Rated kVA @ 1.0PF)	Inverter Rated Current A	Inverters Quantity	Utility Disconnect Rated Current (A)	Terminal Position (Utility & Load)	Losses kW (typical)	Airflow (m ³ /min) Standby	Efficiency % (typical)	Fault Capacity (Icw) kA / Withstand Period ms	Frame Size		Type Code To complete the Type Code: Place 5 for 50Hz or 6 for 60Hz in place of the X
												PCS100 UPS-I	Energy Storage	
150	142	30	30	394	1	900	L	2.3	2.9	98.0	25 / 10	1xB	1xA	PCS100-12-220/x0-01-L-EB01
300	284	30	-	787	2	900	L	3.3	4.8	98.4	25 / 10	1xB	1xA	PCS100-12-220/x0-02-L-EB01
300	284	30	30	787	2	900	L	4.5	4.8	98.4	25 / 10	1xB	2xA	PCS100-12-220/x0-02-L-EB02
450	425	30	30	1181	3	2200	R	5.9	6.7	98.5	50 / 120	2xA 1xC	2xA	PCS100-12-220/x0-03-R-EB02
600	567	30	-	1575	4	2200	R	7.1	8.9	98.5	50 / 120	1xA 2xC	2xA	PCS100-12-220/x0-04-R-EB02
600	567	30	30	1575	4	2200	R	7.1	8.9	98.5	50 / 120	1xA 2xC	3xA	PCS100-12-220/x0-04-R-EB03
750	709	30	-	1968	5	2200	R	7.7	11.0	98.5	50 / 120	1xA 2xC	3xA	PCS100-12-220/x0-05-R-EB03
750	709	30	30	1968	5	2200	R	10.1	11.0	98.5	50 / 120	1xA 2xC	4xA	PCS100-12-220/x0-05-R-EB04
900	851	30	-	2362	6	4200	R	12.6	11.8	98.7	65 / 120	1xA 2xC	3xA	PCS100-12-220/x0-06-R-EB03
900	851	30	30	2362	6	4200	R	12.6	11.8	98.7	65 / 120	1xA 2xC	4xA	PCS100-12-220/x0-06-R-EB04
1200	1135	30	-	3149	8	4200	R	14.3	15.7	98.7	65 / 120	1xA 2xC	4xA	PCS100-12-220/x0-08-R-EB04
1200	1135	30	30	3149	8	4200	R	14.3	15.7	98.7	65 / 120	2xA 2xC	5xA	PCS100-12-220/x0-08-R-EB05
1500	1418	30	-	3936	10	4200	R	16.7	19.8	98.7	65 / 120	2xA 1xC 1xF	5xA	PCS100-12-220/x0-10-R-EB05
1500	1418	30	30	3936	10	4200	R	16.7	19.8	98.7	65 / 120	2xA 1xC 1xF	7xA	PCS100-12-220/x0-10-R-EB07

Note:

208 V operation is achieved by setting a 220 V PCS100 UPS-I to 208 V. This configuration is done at the factory and must be specified at when ordering.

Note:

Frame Size shown in the table defines standard PCS100 UPS-I in linear side-by side layout only. It

does not include optional Fail-Safe Bypass enclosure or dummy enclosure options. If needed, for Fail-Safe Bypass enclosure please add additional 1xC enclosure for PCS100 UPS-I with load current greater than 900 A

Nominal ratings

Rated power	Rated power at stated voltage and power factor available from energy storage for defined autonomy time
Inverter Rated Current	Rated inverter current available during PCS100 UPS-I discharge mode
Utility Disconnect Rated Current	Rated UD current during PCS100 UPS-I online mode

Overload ratings

Inverter	110% of rated current for 30 s
Utility Disconnect	120% of rated current for 60 s every 10 minutes 150% of rated current for 30 s every 10 minutes 200% of rated current for 10 s every 10 minutes 300% of rated current for 5 s every 10 minutes

400 V⁹ Battery Models

Rated power kVA @ 400 V	Rated power kVA @ 380 V	Autonomy time Sec (Rated kVA @ 0.8PF)	Autonomy time Sec (Rated kVA @ 1.0PF)	Inverter Rated Current A	Inverters Quantity	Utility Disconnect Rated Current	Terminal Position (Utility & Load)	Losses kW (typical)	Efficiency % (typical)	Airflow (m ³ /min) Standby	Fault Capacity (Icw) kA / Withstand Period ms	Frame Size		Type Code
												PCS100 UPS-I	Energy Storage	
150	143	30	30	217	1	900	L	2.3	98.5	27	25 / 10	1xB	1xA	PCS100-12-400/50-01-L-EB01
300	285	30	-	433	2	900	L	3.3	98.9	27	25 / 10	1xB	1xA	PCS100-12-400/50-02-L-EB01
300	285	30	30	433	2	900	L	3.3	98.9	27	25 / 10	1xB	2xA	PCS100-12-400/50-02-L-EB02
450	428	30	30	650	3	900	L	4.5	99.0	27	25 / 10	1xA 1xB	2xA	PCS100-12-400/50-03-L-EB02
600	570	30	-	866	4	900	L	5.9	99.0	27	25 / 10	1xB 1xC	2xA	PCS100-12-400/50-04-L-EB02
600	570	30	30	866	4	900	L	5.9	99.0	27	25 / 10	1xB 1xC	3xA	PCS100-12-400/50-04-L-EB03
750	713	30	-	1083	5	2200	R	7.1	99.1	35	50 / 120	1xA 2xC	3xA	PCS100-12-400/50-05-R-EB03
750	713	30	30	1083	5	2200	R	7.1	99.1	35	50 / 120	1xA 2xC	4xA	PCS100-12-400/50-05-R-EB04
900	855	30	-	1299	6	2200	R	7.7	99.1	35	50 / 120	1xA 2xC	3xA	PCS100-12-400/50-06-R-EB03
900	855	30	30	1299	6	2200	R	7.7	99.1	35	50 / 120	1xA 2xC	4xA	PCS100-12-400/50-06-R-EB04
1200	1140	30	-	1732	8	2200	R	10.1	99.2	35	50 / 120	2xA 2xC	4xA	PCS100-12-400/50-08-R-EB04
1200	1140	30	30	1732	8	2200	R	10.1	99.2	35	50 / 120	2xA 2xC	5xA	PCS100-12-400/50-08-R-EB05
1500	1425	30	-	2165	10	2200	R	12.6	99.2	35	50 / 120	2xA 1xC 1xF	5xA	PCS100-12-400/50-10-R-EB05
1500	1425	30	30	2165	10	2200	R	12.6	99.2	35	50 / 120	2xA 1xC 1xF	7xA	PCS100-12-400/50-10-R-EB07
1800	1710	30	-	2598	12	4200	R	14.3	99.2	45	65 / 120	2xA 1xC 1xG	6xA	PCS100-12-400/50-12-R-EB06
1800	1710	30	30	2598	12	4200	R	14.3	99.2	45	65 / 120	2xA 1xC 1xG	8xA	PCS100-12-400/50-12-R-EB08
2100	1995	30	-	3031	14	4200	R	16.7	99.2	45	65 / 120	3xA 1xC 1xG	7xA	PCS100-12-400/50-14-R-EB07
2100	1995	30	30	3031	14	4200	R	16.7	99.2	45	65 / 120	3xA 1xC 1xG	9xA	PCS100-12-400/50-14-R-EB09
2400	2280	30	-	3464	16	4200	R	18.9	99.2	45	65 / 120	3xA 1xC 1xG	8xA	PCS100-12-400/50-16-R-EB08
2400	2280	30	30	3464	16	4200	R	18.9	99.2	45	65 / 120	3xA 1xC 1xG	10xA	PCS100-12-400/50-16-R-EB010

⁹ It is possible to supply 400 V, 60 Hz models also. Please contact the factory.

Note:
380 V operation is achieved by setting a 400 V PCS100 UPS-I to 380 V. This configuration is done at the factory and must be specified at when ordering.

Note:
Frame Size shown in the table defines standard PCS100 UPS-I in linear side-by side layout only. It

does not include optional Fail-Safe Bypass enclosure or dummy enclosure options. If needed, for Fail-Safe Bypass enclosure please add additional 1xC enclosure for PCS100 UPS-I with load current greater than 900 A

Nominal ratings

Rated power	Rated power at stated voltage and power factor available from energy storage for defined autonomy time
Inverter Rated Current	Rated inverter current available during PCS100 UPS-I discharge mode
Utility Disconnect Rated Current	Rated UD current during PCS100 UPS-I online mode

Overload ratings

Inverter	110% of rated current for 30 s
Utility Disconnect	120% of rated current for 60 s every 10 minutes 150% of rated current for 30 s every 10 minutes 200% of rated current for 10 s every 10 minutes 300% of rated current for 5 s every 10 minutes

480 V Battery Models

Rated power kVA @ 480 V	Rated power kVA @ 440 V	Rated power kVA @ 415 V	Autonomy time Sec (Rated kVA @ 0.8PF)	Autonomy time Sec (Rated kVA @ 1.0PF)	Inverter Rated Current A	Inverters Quantity	Utility Disconnect Rated Current A	Terminal Position (Utility & Load)	Losses kW (typical)	Efficiency % (typical)	Airflow (m ³ /min) Standby	Fault Capacity (Icw) kA / Withstand Period ms	Frame Size		Type Code (To complete the Type Code: Place 5 for 50Hz or 6 for 60Hz in place of the X
													PCS100 UPS-I	Energy Storage	
150	138	130	30	30	180	1	900	L	2.3	98.5	27	25 / 10	1xB	1xA	PCS100-12-480/x0-01-L-EB01
300	275	259	30	-	361	2	900	L	3.2	98.9	27	25 / 10	1xB	1xA	PCS100-12-480/x0-02-L-EB01
300	275	259	30	30	361	2	900	L	3.2	98.9	27	25 / 10	1xB	2xA	PCS100-12-480/x0-02-L-EB02
450	413	389	30	30	541	3	900	L	4.3	99.1	27	25 / 10	1xA 1xB	2xA	PCS100-12-480/x0-03-L-EB02
600	550	519	30	-	722	4	900	L	5.5	99.1	27	25 / 10	1xB 1xC	2xA	PCS100-12-480/x0-04-L-EB02
600	550	519	30	30	722	4	900	L	5.5	99.1	27	25 / 10	1xB 1xC	3xA	PCS100-12-480/x0-04-L-EB03
750	688	648	30	-	902	5	900	L	6.6	99.1	35	50 / 120	1xB 1xC	3xA	PCS100-12-480/x0-05-L-EB03
750	688	648	30	30	902	5	900	L	6.6	99.1	35	50 / 120	1xB 1xC	4xA	PCS100-12-480/x0-05-L-EB04
900	825	778	30	-	1083	6	2200	R	7.1	99.2	35	50 / 120	1xA 2xC	3xA	PCS100-12-480/x0-06-R-EB03
900	825	778	30	30	1083	6	2200	R	7.1	99.2	35	50 / 120	1xA 2xC	4xA	PCS100-12-480/x0-06-R-EB04
1200	1100	1038	30	-	1443	8	2200	R	9.1	99.2	35	50 / 120	2xA 2xC	4xA	PCS100-12-480/x0-08-R-EB04
1200	1100	1038	30	30	1443	8	2200	R	9.1	99.2	35	50 / 120	2xA 2xC	5xA	PCS100-12-480/x0-08-R-EB05
1500	1375	1297	30	-	1804	10	2200	R	11.2	99.3	35	50 / 120	2xA 1xC 1xF	5xA	PCS100-12-480/x0-10-R-EB05
1500	1375	1297	30	30	1804	10	2200	R	11.2	99.3	35	50 / 120	2xA 1xC 1xF	7xA	PCS100-12-480/x0-10-R-EB07
1800	1650	1556	30	-	2165	12	2200	R	13.6	99.2	35	50 / 120	2xA 1xC 1xG	6xA	PCS100-12-480/x0-12-R-EB06
1800	1650	1556	30	30	2165	12	2200	R	13.6	99.2	35	50 / 120	2xA 1xC 1xG	8xA	PCS100-12-480/x0-12-R-EB08
2100	1925	1816	30	-	2526	14	4200	R	14.9	99.3	45	65 / 120	3xA 1xC 1xG	7xA	PCS100-12-480/x0-14-R-EB07
2100	1925	1816	30	30	2526	14	4200	R	14.9	99.3	45	65 / 120	3xA 1xC 1xG	9xA	PCS100-12-480/x0-14-R-EB09
2400	2200	2075	30	-	2887	16	4200	R	16.6	99.3	45	65 / 120	3xA 1xC 1xG	8xA	PCS100-12-480/x0-16-R-EB08
2400	2200	2075	30	30	2887	16	4200	R	16.6	99.3	45	65 / 120	3xA 1xC 1xG	10xA	PCS100-12-480/x0-16-R-EB10

Note:
415 V or 440 V operation is achieved by setting a 480 V PCS100 UPS-I to 415 V or 440 respectively. This configuration is done at the factory and must be specified at when ordering.

Note: Frame Size shown in the table defines standard PCS100 UPS-I in linear side-by side layout

only. It does not include optional Fail-Safe Bypass enclosure or dummy enclosure options. If needed, for Fail-Safe Bypass enclosure please add additional 1xC enclosure for PCS100 UPS-I with load current greater 900 A.

Nominal ratings

Rated power	Rated power at stated voltage and power factor available from energy storage for defined autonomy time
Inverter Rated Current	Rated inverter current available during PCS100 UPS-I discharge mode
Utility Disconnect Rated Current	Rated UD current during PCS100 UPS-I online mode

Overload ratings

Inverter	110% of rated current for 30 s
----------	--------------------------------

Utility Disconnect	120% of rated current for 60 s every 10 minutes
	150% of rated current for 30 s every 10 minutes
	200% of rated current for 10 s every 10 minutes
	300% of rated current for 5 s every 10 minutes

DIMENSIONS, LAYOUTS AND CLEARANCES

Dimensions and Weights

The following tables show the dimensions and weights of different types of enclosures.

Note: Allow $\pm 10\%$ tolerance for all weights shown in tables below.

Enclosure Size	Dimensions H x W x D mm	Enclosure Type		Weight ¹⁰ kg		
Shared Enclosures						
B	2154 x 1209 x 804	Inverters, Utility Disconnect and Coupling Transformer	150 kVA	785		
			300 kVA	1120		
		Inverters and Utility Disconnect	450 kVA	685		
			600 kVA	770		
			750 kVA	850		
		Dedicated Enclosures				
A	2154 x 809 x 804	Inverter Enclosure	Master	690 (with 5 inverters)		
			Slave	633 (with 5 inverters)		
		Ultracapacitor Energy Storage	One string	450		
			Two strings	690		
		Battery Energy Storage	One string	2043		
			Empty	639		
		Coupling Transformer	220 V / 208 V	1030		
			400 V / 480 V	1010		
		C	2154 x 1209 x 804	Utility Disconnect	2200 A	900
					4200 A	980
Fail-Safe Bypass	2200 A			700		
	4200 A			790		
Coupling Transformer				Typically, 2 kg/kVA		
D	2154 x 809 x 1204			Coupling Transformer	Contact ABB for actual weights.	
F	2154 x 1209 x 1204	Coupling Transformer				
G	2154 x 1600 x 1204	Coupling Transformer				

¹⁰ Allow $\pm 10\%$ tolerance for all weights shown in tables

INDIVIDUAL ENCLOSURES

Individual Enclosures – Plan View

The following plan views show the dimensions and required clearances of the enclosures.

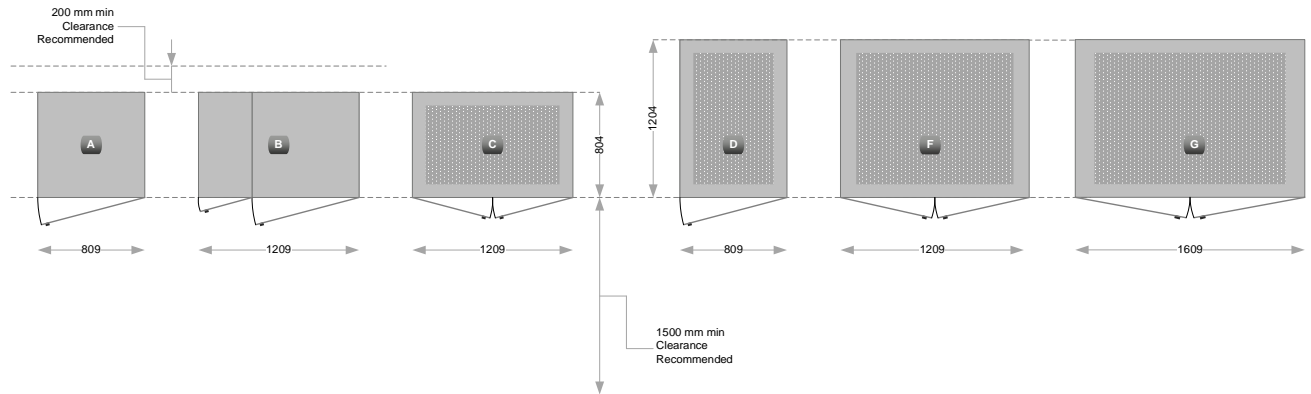

Individual Enclosures – Elevations

The following front elevations show the height of the enclosures and clearance required above each enclosure.

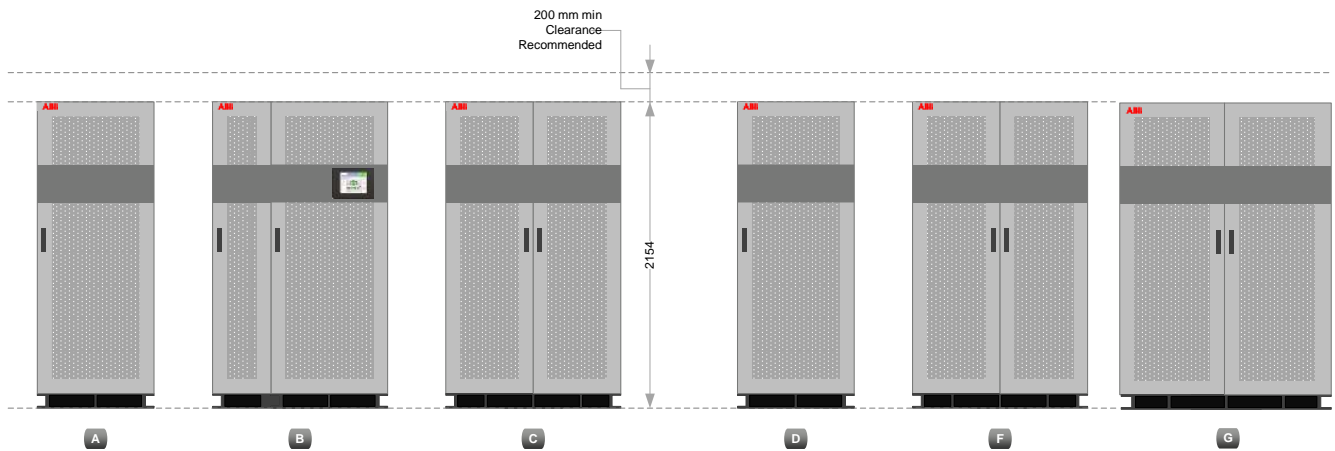

Clearances

The following clearances are required for all enclosures:

- Allow 200 mm (minimum) above
- Allow 1500 mm (recommended) clearance in front
- No side clearance required

Side clearance to the wall at the side where the cabinet outmost hinges of minimum 400 mm is recommended to allow the doors to open sufficiently. The doors must open 120° to allow

normal cabinet to access the PCS100 UPS-I module replacement.



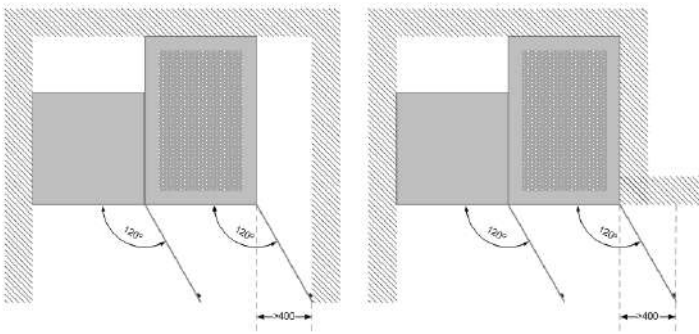

Allow 400 mm (recommended) clearance at the rear for testing fans, access to interconnecting wiring and installation of bus bars. 200 mm at the rear is the minimum clearance required for ventilation of enclosures placed side-by-side and 400 mm if placed back-to-back. (Exception: The Coupling Transformer and Utility Disconnect can be placed back-to-back without any clearance.)



Layout Plans – PCS100 UPS-I Subassemblies

These plans assume PCS100 UPS-I systems without optional Fail-Safe Bypass enclosure. For Energy Storage layout plans, see Layout “Layout Plans – Energy Storage” below.

Side-by-Side Layouts

-  Inverter
-  Utility Disconnect
-  Coupling Transformer
-  Customer connection side

Frame Size: 1xB

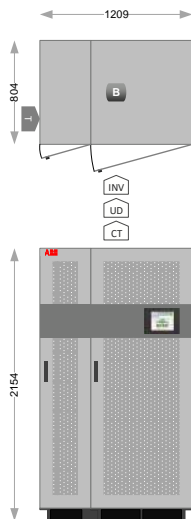

Frame Size: 1xB 1xA

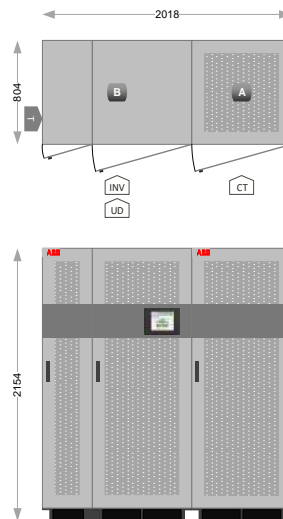

Frame Size: 1xB 1xC

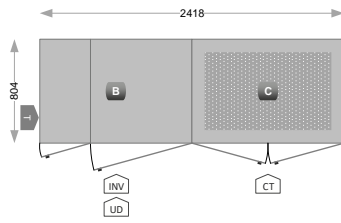

Frame Size: 2xA 1xC

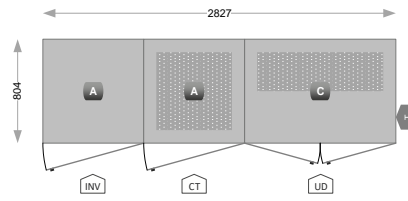

Frame Size: 1xA 2xC

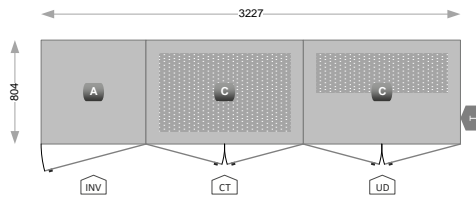

Frame Size: 2xA 2xC

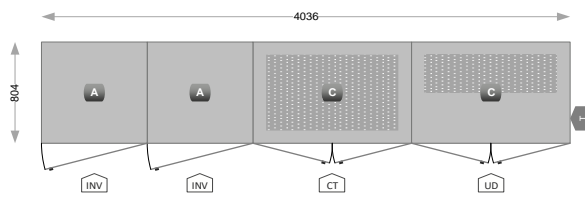

Frame Size: 2xA 1xC 1xF (for 1500 kVA)

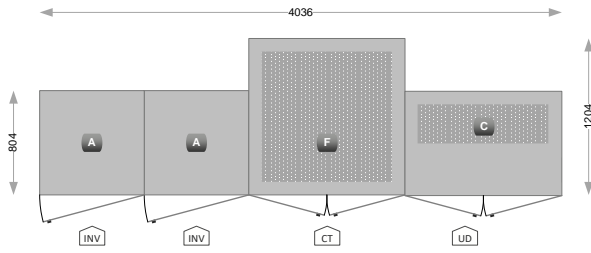

Frame Size: 3xA 1xC 1xG

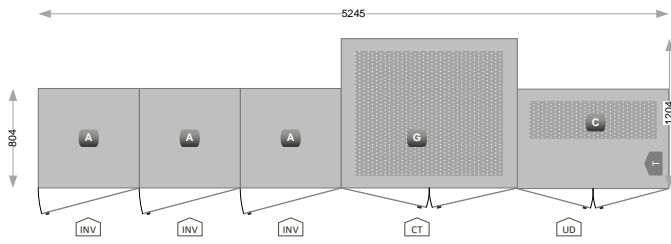

Back-by-Back Layouts

In addition to linear Side-by-Side arrangement, certain models can be arranged in a Back-to-Back layout.

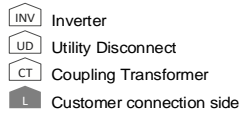

Frame Size: 1xA 1xC 1xD

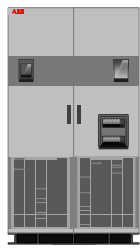
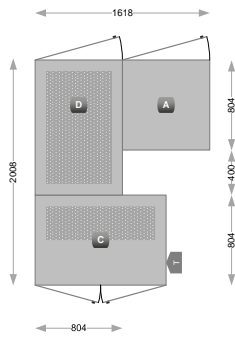

Front View



Back View

Frame Size: 2xA 1xC 1xF

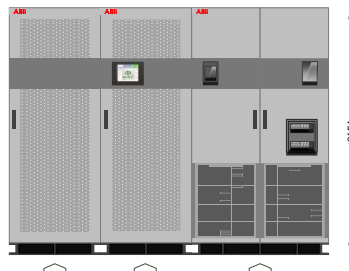
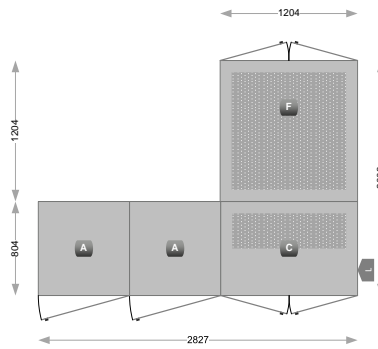

Front View

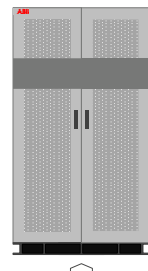

Back View

Frame Size: 2xA 1xC 1xD

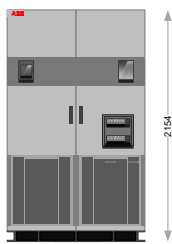
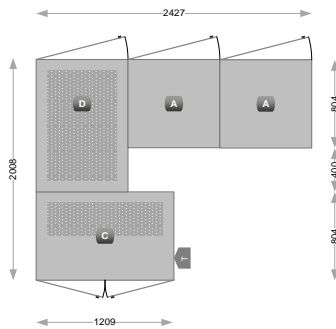

Front View

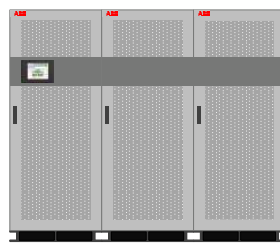

Back View

Frame Size: 3xA 1xC 1xF

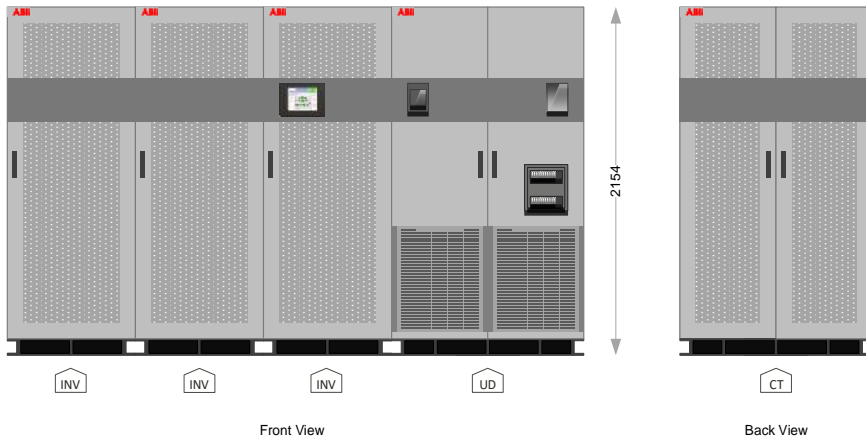
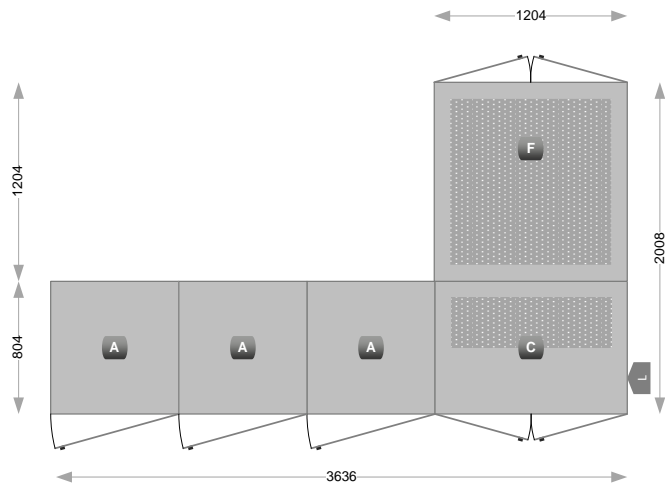

Layout Plans – Energy Storage

The following plans relate to the enclosure quantities specified in the Energy Storage.

Ultracapacitor Energy Storage

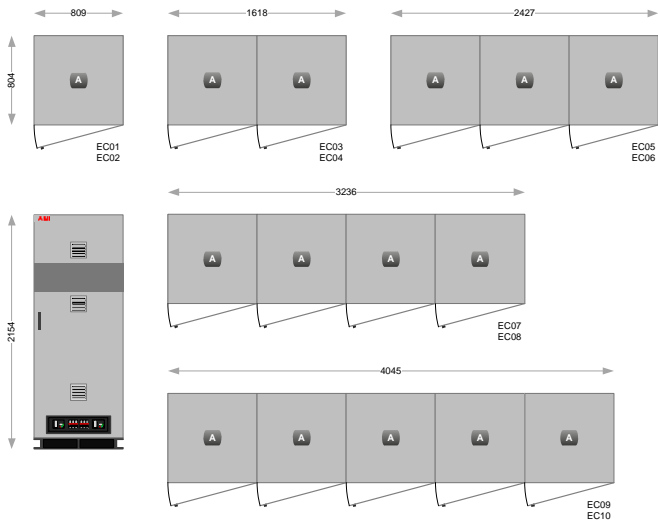

Battery Energy Storage

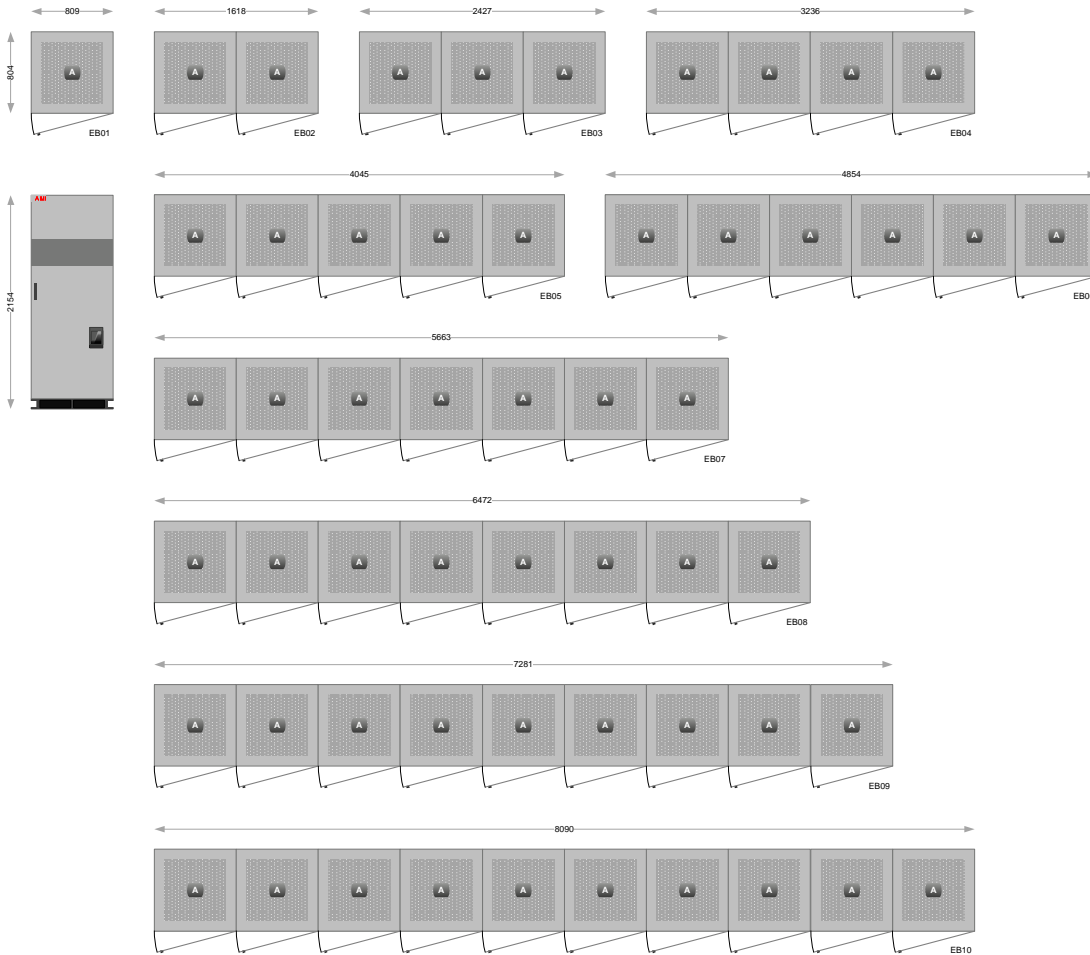

Layout Plans – Complete Systems Example

Due to the many different configurations all possible layouts are not show below. Please use the PCS100 UPS-I Sizing Tool as to obtain the system layout for your configuration.

The following example layouts are showing:

PCS100 UPS-I	frame size: 2xA 1xC 1xF
Energy Storage	frame size: 3xA
Optional Fail-Safe Bypass	frame size: 1xC

Side-by-Side Layout

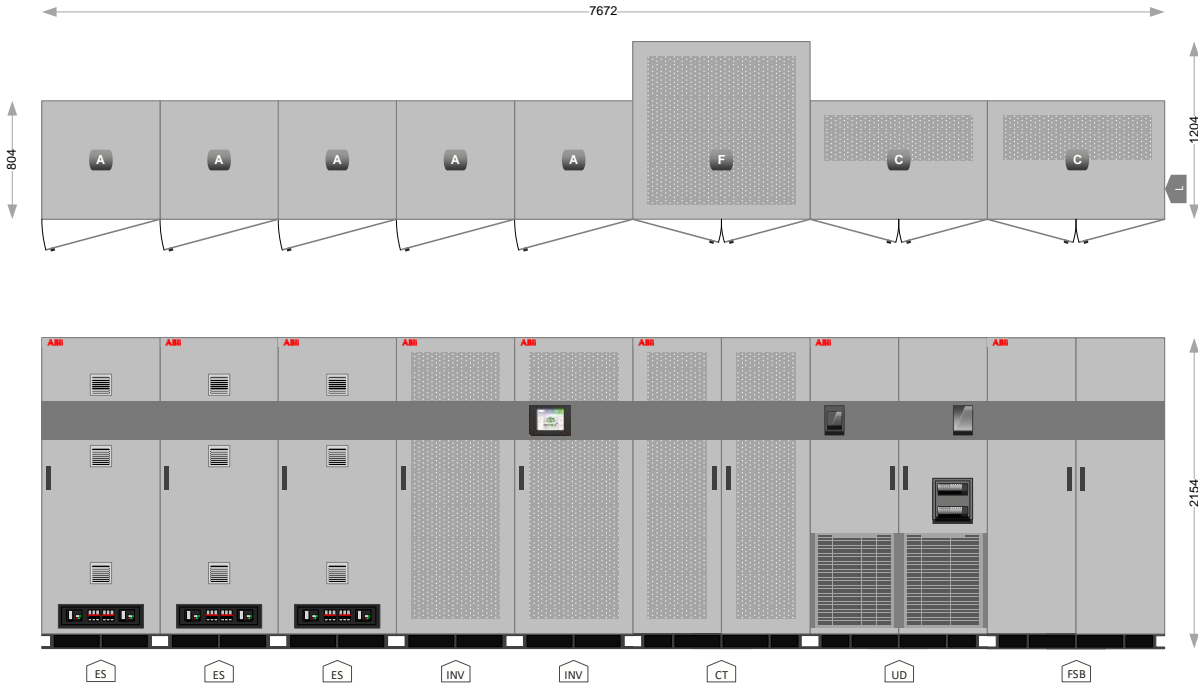

Note: Coupling transformer enclosure G is available from 1800 kVA. Coupling transformer enclosure F is available for 1500 kVA only.

Back-to-Back Layout

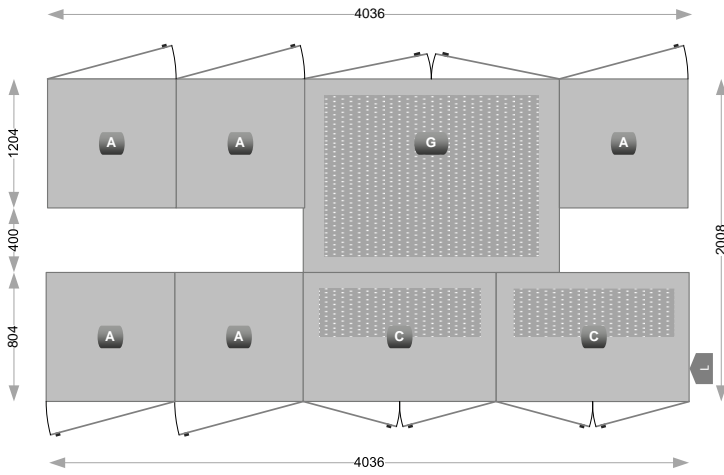

Front View

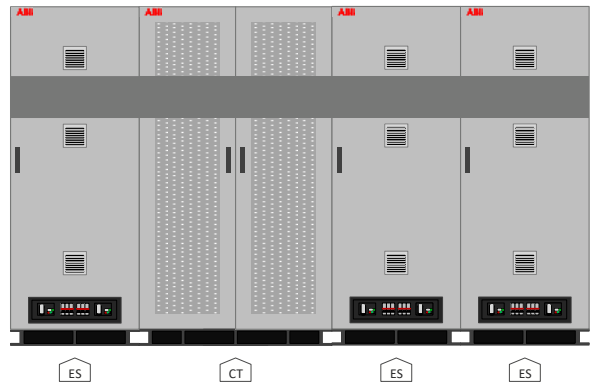

Back View

Note: Coupling transformer enclosure G is available from 1800 kVA. Coupling transformer enclosure F is available for 1500 kVA only.

EXAMPLE SYSTEMS

PCS100-12-400/50-02-L-EC01

Rating:
300 kVA, 400 V, 50 Hz
Energy Storage:
Ultracapacitor
300 kW for 2 s
Frame Size:
PCS100 UPS-I 1xB
Energy Storage: 1xA



PCS100-12-220/60-10-R-EC04+FS4

Rating:
1500 kVA, 220 V, 60 Hz
Energy Storage:
Ultracapacitor
1200 kW for 2 s
Frame Size:
PCS100 UPS-I 2xA 1xF 1xC
Energy Storage: 2xA
Optional FSB: 1xC



OPTIONS

Following options are available for the PCS100 UPS-I:

Plus Code	Option Description
+BB	Back-to-Back Layout Plan
+FS2	2200 A Fail-Safe Bypass
+FS4	4200 A Fail-Safe Bypass
+TE	Cable Termination Enclosure
+DMY	Dummy Enclosure
+NBxx	Empty Battery Energy Storage Enclosure

+BB Back-to-Back Layout Plan

In addition to standard linear Side-by-Side arrangement, certain models can be arranged in a Back-to-Back configuration.

To specify a back-to-back layout, add the plus code +BB.

Back-to-back layout is available to PCS100 UPS-I models with 2200 A and 4200 A Utility Disconnect systems.

Additional information and layouts are available in PCS100 UPS-I Sizing Tool.

+FS2/FS4 Fail-Safe Bypass

For PCS100 UPS-I that have either a 2200 A or 4200 A Utility Disconnect, a Fail-Safe Bypass is not supplied unless specified as an option.

To specify a Fail-Safe Bypass, add the plus code in the type code.

- For a 2200A Fail-Safe Bypass +FS2
- For a 4200A Fail-Safe Bypass +FS4



Note:

Do not specify a Fail-Safe Bypass for PCS100 UPS-Is that have a 900 A Utility Disconnect. For PCS100 UPS-Is with a 900 A Utility Disconnect, an integrated Fail-Safe Bypass is included as standard. To determine the type of Utility Disconnect size of selected PCS100 UPS-I model, refer to model tables.

Note:

Factory supplied Fail-Safe Bypass provide an electrical bypass of the PCS100 UPS-I. If electrical isolation is required for servicing, an external bypass is required. The external bypass is not supplied by the factory.

TE Cable Termination Enclosure

For PCS100 UPS-I systems with a 2200 A or 4200 A Utility Disconnect or optional Fail-Safe Bypass standard termination is busbar connection.

Cable Termination Enclosure option provides an additional enclosure which contains terminals for cable connection for input and output.

The 230 V auxiliary fan supply needs to be supplied externally.



+DMY Dummy Enclosure

Dummy enclosures are completely empty enclosures that can be ordered for cosmetic reasons, e.g., to fill a gap between other enclosures in Back-to-Back layout.

Three sizes are available, 400 mm wide, 800 mm wide and 1200 mm wide.

Dummy Enclosure size is determined based on the selected PCS100 layout.

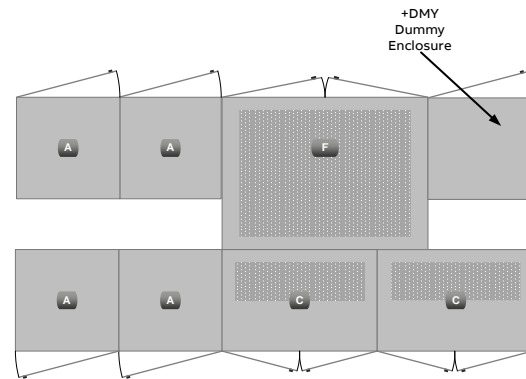

+NBxx Empty Battery Energy Storage Enclosure

The PCS100 UPS-I can be supplied without batteries from the factory.

Empty battery enclosures can be ordered to fit ABB specified batteries.

Replace the xx in +NBxx with number of needed Battery Energy Storage Enclosures.

Each empty Battery Energy Storage Enclosure is supplied with a DC Circuit Breaker and wiring for connecting the batteries.



USER INTERFACE

Graphic Display Module

The primary user interface for configuration of the PCS100 UPS-I is via the Graphic Display Module (GDM) which is mounted in the door of the inverter enclosure. It allows local control of the PCS100 UPS-I and shows the system status and provides the access to the operating parameters and event history.

The GDM interface consists of several pages; each page has a navigation & control panel and the status

bar at the top. The Navigation & Control Panel and the Status Bar are displayed at all times.

The navigation panel consists of buttons allowing page selection and the control panel consists of a Start (I) / Stop (O) / Reset button allowing local control of the product.

The status bar displays the current product status and any warning or fault condition that may be present.

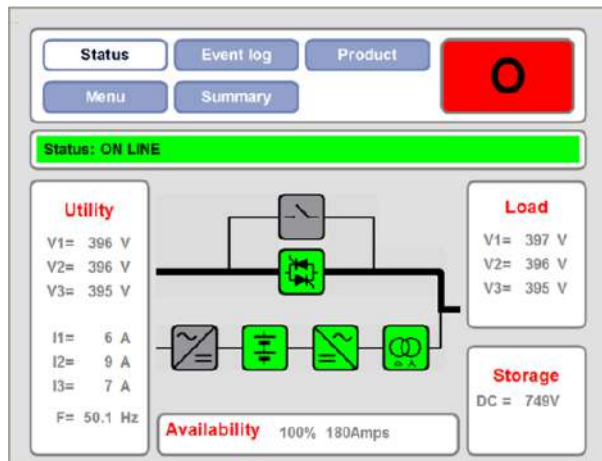

Feature	GDM
Display resolution	1024 × 600 pixels
Display size	10.1"
Color Graphic display	Yes
Touch Sensitive display	Yes
Full descriptions of status and faults	Yes
Local Start/Stop Reset Control	Yes
Status Display	Yes
Parameter adjustment	Yes
Number of Event Log records stored	10000
Event log can be downloaded to a PC	Yes
Remote Web Pages	Yes
Modbus TCP connection	Yes

Remote Monitoring

The GDM provides remote access for monitoring purpose. The following monitoring connections are available.

Communication Type	Description	Connection
Remote Web Pages	HTML server - Ethernet connection	Standard RJ45
Monitoring system	Modbus TCP	Standard RJ45

Remote Web Pages

Remote Web Pages are a set of web pages that are similar in format to the standard GDM and accessed through the integrated web server via the GDM Ethernet connection. Through this interface the users can remotely access the status and operating

parameters. Viewing and downloading of event history and service logs is also available. Access is via the Ethernet port of the GDM and web pages can be viewed any standard web browser on a device connected to the same network.

Modbus TCP

A Modbus TCP connection is also provided via the Ethernet port of the GDM user interface. Read Only

access is available to operating parameters such as voltages, currents and power levels.

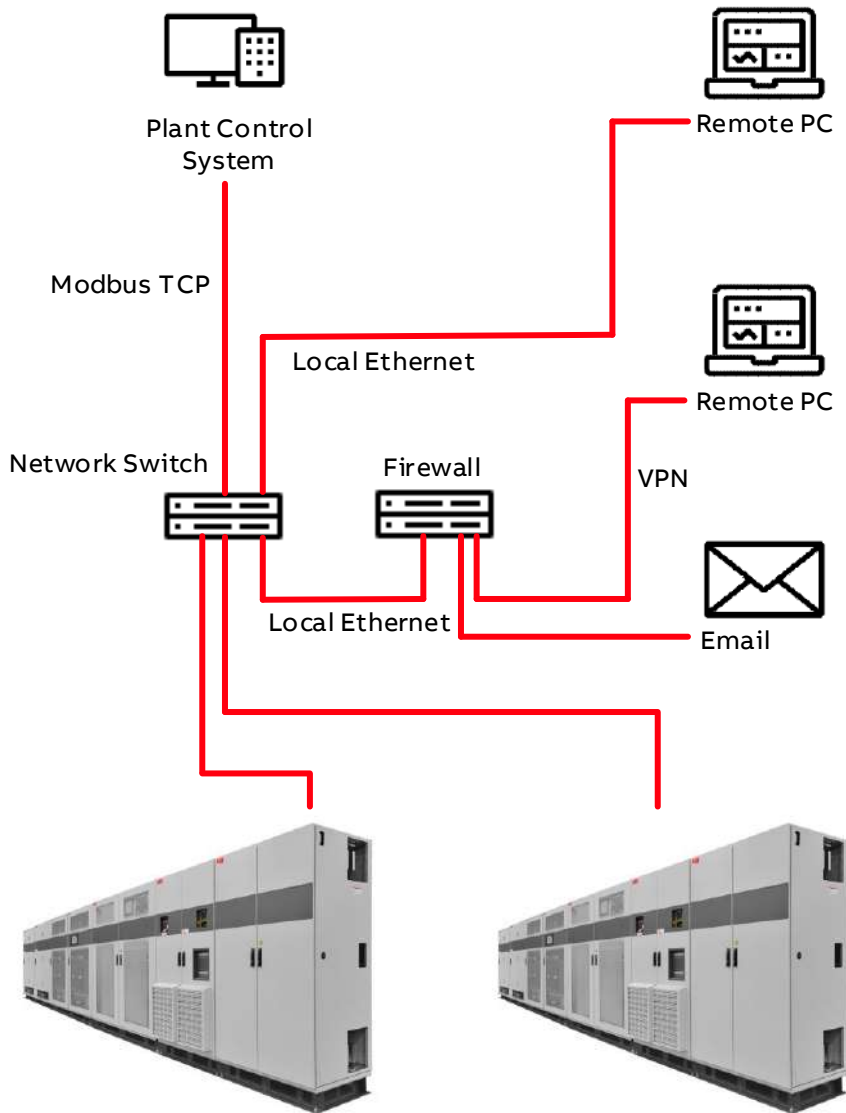

USER CONNECTIONS

Power Connections

Following connections are required for the PCS100 UPS-I:

Terminal Label	Function
L1, L2, L3	Utility Supply (Input)
L1', L2' L3'	Load (Output)
N	Neutral

900 A Utility Disconnect

The PCS100 UPS-I systems with a 900 A Utility Disconnect have the main input and output connections on the left side.

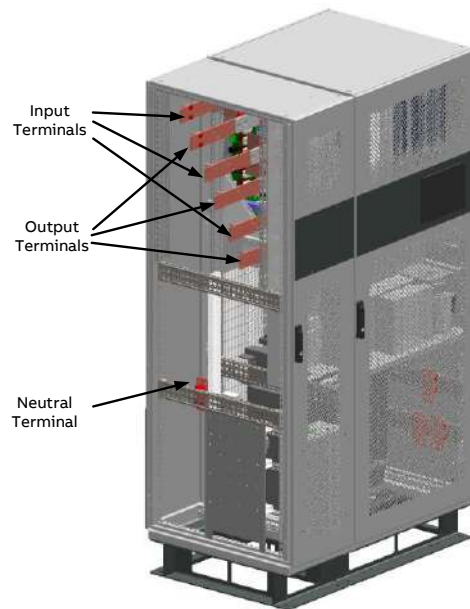

2200 A and 4200 A Utility Disconnect

The PCS100 UPS-I systems with a 2200 A and 4200 A Utility Disconnect have the main input and output terminals on right side of the Utility Disconnect Enclosure.

Note:

For the PCS100 UPS-I systems with included +FSx Fail-Safe Bypass option connection terminals are located on the right-side panel of the Fail-Safe Bypass Enclosure.

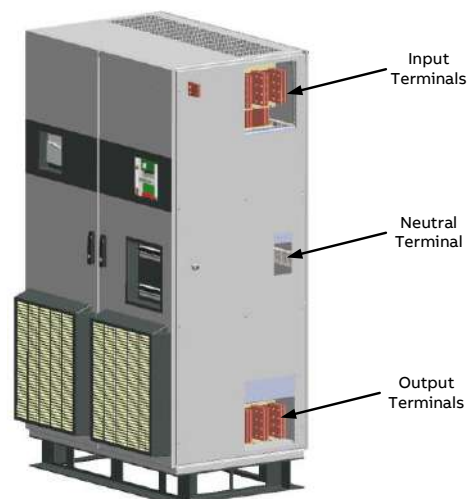

Control Connections

The PCS100 UPS-I includes control connections for the need of local control or monitoring of the system.

Control connection terminals are located on AUX Master Module at the bottom of the master controller enclosure

Control Connection	Description
3 Relay Outputs	PCS100 UPS-I status information 250 Vac/30 Vdc, 1 A
1 Isolated Thermal Switch	Transformer over temperature information 24 Vdc/24 Vac, 1 A Normally closed (NC) contact
2 Digital Inputs	PCS100 UPS-I Remote control Start/Stop/Inhibit Dry contacts only

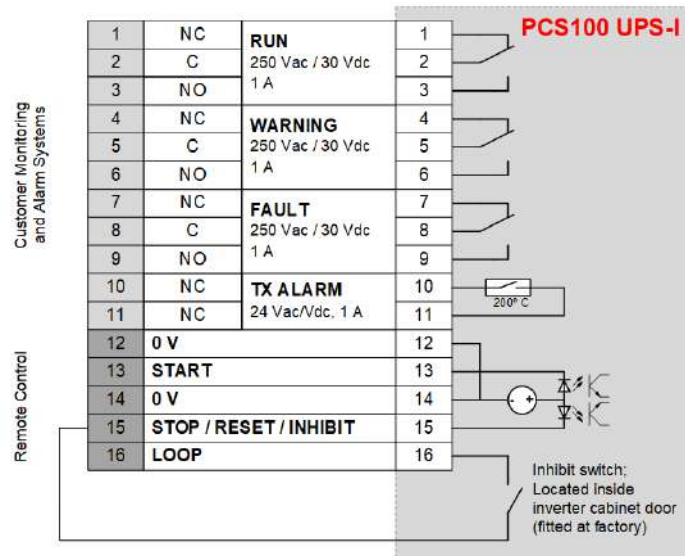

Following control connections are available for wired remote control or monitoring of PCS100 UPS-I.

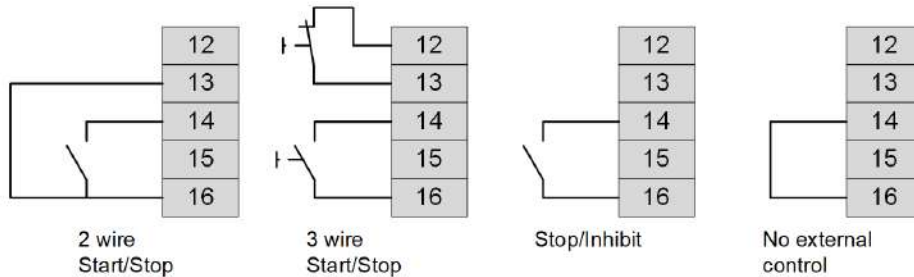

Note: The "No external control" link is fitted in factory as standard.

Emergency Power Off (EPO)

Where required Emergency Power Off (EPO) function may be implemented using a latched emergency mushroom button or control, to close a normally open shunt trip for the supply breaker (to remove supply to the PCS100 UPS-I) and open a normally closed Stop control circuit, as shown in figure, to prevent the PCS100 UPS-I from supplying the load from energy storage.

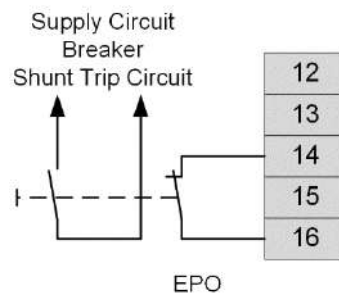

INSTALLATION REQUIREMENTS

Input Circuit Protection

A power system circuit breaker is required to provide overload and short circuit protection to the PCS100 UPS-I and its load.

Short Circuit Protection

The power system fault current (kA) must not exceed the fault capacity of the PCS100 UPS-I. A circuit breaker that is set to clear a short circuit failure (within the PCS100 UPS-I's withstand period) is required. For PCS100 UPS-I fault capacities and withstand periods refer to the model tables earlier in this catalogue. Withstand period is not applicable to PCS100 UPS-I models that have a Utility Disconnect rated at 900 A or less. These PCS100 UPS-I models require current limiting 'moulded case circuit breakers' (MCCBs). Current limiting MCCBs provide very fast clearing of short circuit fault currents. ABB T5 or T6 Series MCCBs or equivalents are suitable.

Input Overload Protection – Utility Disconnect

The power system circuit breaker should be set to the overload capability stated for the utility input in the specification section of this catalogue.

Maintenance Bypass

ABB recommends that a maintenance bypass (not supplied with the PCS100 UPS-I) is fitted. The maintenance bypass allows maintenance to be performed on the PCS100 UPS-I without disruption to the load.

Floor Requirements

All enclosures must be installed on a horizontal fireproof surface.

Do not exceed $\pm 0.2^\circ$ change in slope between adjacent enclosures.

Do not exceed ± 5 mm in elevation between adjacent enclosures.

Note: Additional precaution should be taken for PCS100 UPS-I system weight, especially in battery PCS100 UPS-I systems where one energy storage enclosure weights 2043 kg.

Electromagnetic Compatibility (EMC)

The PCS100 UPS-I is designed for commercial and industrial applications. It is not suitable for

connection to a low-voltage utility that is supplying residences unless additional measures are taken as per IEC 62040-2.

Location

The PCS100 UPS-I is designed for location in a restricted access location only. The PCS100 UPS-I is designed for connection by fixed wiring. PCS100 UPS-I system location should be clean electrical room with controlled environment temperature and humidity according to the requirements under Technical Data section. Because of different limits of ambient temperatures of PCS100 UPS-I system and energy storage (40 °C and 25 °C) for cost saving on HVAC systems it is advisable to install them to different electrical rooms.

Phase Rotation

The PCS100 UPS-I does not support negative phase rotation.

Power Systems

The PCS100 UPS-I is designed for use in TN power systems. For any other type of power distribution system contact ABB for more information.

Harmonics

The PCS100 is designed to tolerate disturbances such as voltage and current harmonics in the load or supply. Excessive distortion can lead to the stressing of components leading to reduction in the lifetime of some components. For harmonics >8%THDv contact ABB for more information.

Load Imbalance

Excessive load imbalance can result in high currents in the neutral cables and connection. For load imbalance >10% contact ABB for more information.

Supply transformer

During complete electrical system design precaution should be taken for PCS100 UPS-I system supply transformer capacity, especially for battery models because of battery charging period after PCS100 UPS-I discharging mode. As fast charging of batteries through PCS100 UPS-I Inverters can be up to 30 minutes additional load on supply transformer should be taken in consideration.

¹¹ A Fail-Safe Bypass (if fitted) is not a substitute for a maintenance bypass because it does not offer isolation of the PCS100 UPS-I.

¹ Current level during fast charging period can be set between 0% and 40% of inverter rated current, with standard setting of 10% for battery models.

SERVICE AND TECHNICAL SUPPORT

ABB Power Conditioning provide global service and support of installation and commissioning of PCS100 products

Comprehensive global services portfolio

ABB services span the entire product ownership life cycle:

- Pre-purchase engineering
- Installation and commissioning
- Technical support
- Training
- Preventive and corrective maintenance and maintenance spare parts kits
- Retrofit and refurbishment
- Globally available, supported by regional service hubs and operating in more than 100 countries
- Spare part availability and stocking
- On-site repairs
- 24 x 365 local support line

Custom tailored service contracts

- 24 x 365 local support line
- ABB services can be packaged into a custom service contract
- Tailored to the specific needs of each customer
- Contracts can be made at any stage of ABB product ownership

Service contracts provide customers with improved cost controls, increased operational efficiency, lower capital expenditures, and extend ABB product life time.

Life cycle management

ABB's life cycle management model maximizes the value of the equipment and maintenance investment

by maintaining high availability, eliminating unplanned repair costs and extending the lifetime of the system. Life cycle management includes:

- Spare parts and expertise throughout the life cycle
- Efficient product support and maintenance for improved reliability
- Functionality upgrades to the initial product

Training

- Product training includes installation, commissioning, and maintenance
- Training either at ABB Universities or at a customer site
- Training can be included in an ABB services contract

Engineering and technical support

ABB's engineering team provides the necessary electrical, protective and monitoring equipment, delivering a high level of energy continuity and superior power quality in a safe and cost-effective system. The PCS100 is available in several capacities, depending on the scope of application.

- Pre-purchase engineering to help select and integrate ABB PCS100 products
- Customer assistance in sizing and modeling of systems
- Other life cycle engineering and technical support is available by phone, email, or on-site visits, or as agreed in an ABB services contract
- Redundant internal bypass design increases reliability and availability and is part of a proven family of global ABB products
- Scalable building block design



ADDITIONAL DOCUMENTS

Document Number	Document Name
2UCD120000E001	PCS100 UPS-I User Manual
2UCD120000E004	PCS100 UPS-I Installation Manual
2UCD120000E013	PCS100 UPS-I External or Customer Supplied Batteries - Requirements Specification
2UCD120000E014	PCS100 UPS-I Understanding and Adjusting the PCS100 UPS-I Voltage Event Detector
2UCD120000E015	PCS100 UPS-I Bypass Trigger for PCS100 UPS-I Maintenance Bypass
2UCD120000E017	PCS100 UPS-I Application to other than center referenced solid earthed power systems
2UCD120000E018	PCS100 UPS-I Application of Standard PCS100 UPS-I to extended autonomy and battery sizing for 30 - 300 second applications
2UCD120000E019	PCS100 UPS-I Product Efficiency AN



<https://library.abb.com>

—
ABB Ltd.

111 Main North Road
4110, Napier
New Zealand

abb.com/ups

2UCD12000E002_K



© Copyright 2012 ABB. All rights reserved.
Specifications subject to change without notice.